

Complete range

Gun drills

 **STOCK**

Chip – by Chip – to the Top

SuperV

- solid carbide spiral deep hole drills for highest cutting speeds and feed rates
- drilling depths from 15xD to 40xD
- nominal diameter from 1.40 to 16.00 mm
- optimised flute design for optimal chip evacuation
- special solutions for wet machining of aluminium





SuperT

- single- and two-fluted gun drills for highest precision
- drilling depths up to 80xD with only one tool
- manufactured from 0.9 mm nominal diameter
- with and without chip breaker
- for universal application

Deep hole drills for conventional machines, e.g. machining centres

THE TWISTED ONE

from diameter 1.4 to 16.0 mm,
for the machining of various steels, stainless materials
or special alloys

Product overview page 8-9
Product information from page 18
Application recommendations page 51-53

THE CONVENTIONAL ONE

universal deep hole drills for a wide range of materials,
especially for small diameters, cutting edge and tube made of carbide,
bright version particularly suitable for non-ferrous metals

Product overview page 10-11
Product information from page 25
Application recommendations page 55

THE DURABLE ONE

high feed rates, suitable for MQL,
made of solid carbide, for universal application

Product overview page 12-13
Product information from page 33
Application recommendations page 55

THE CONVENTIONAL ONE WITH BRAZED CARBIDE HEAD

universal deep hole drills with brazed carbide head in two versions:
- with lateral chip breaker for long-chipping materials
- without chip breaker for alloyed and high alloyed steels

Product overview page 14-15
Product information from page 36
Application recommendations page 55





Deep hole drills for deep hole drilling machines

THE CONVENTIONAL ONE FOR DEEP HOLE DRILLING MACHINES

standard gun drills for universal application, well balanced range of diameter and tool length, ex-stock range for customers with limited time, e.g. in mould and die production

Product overview page 16-17
Product information from page 45
Application recommendations page 55

TECHNICAL SECTION



Application recommendations from page 50
Technical information from page 56
Special solutions for single-fluted gun drills with interchangeable insert TBE-WP page 60
Questionnaires from page 61

The drilling process on conventional machines

Recommendations

- For drilling depths in excess than $40 \times D$ (on conventional machining centers) we recommend the use of two or more gun drills, e.g. dia. 10 x 400 mm and dia. 9.95 x 800 mm.
- For machining of long-chipping materials we recommend the use of gun drills with polished flutes.
- Generally we recommend the use of soluble oil with a minimum oil content of 10 %.
- When drilling in aluminium with a Si-content of less than 1 % with the recommended cutting rates of i.e. V_c 160 m/min we advise to advance to the final speed in several steps.

Cutting parameters can be reduced if cooling parameters are insufficient.
Pressure increase systems are also an option.

Procedure

In order to achieve optimal machining results when producing deep holes especially spotting on radii and/or on an uneven surface structure, we recommend the following machining steps:

1. Initial milling of surface, i.e. with our centre cutting end mill SuperF-UT-N. The surface must be machined at right angles to the entry angle of the drilling operation.
2. Production of a cylindrical pilot hole (tolerance F9) with a drilling depth of $1.5 \times D$. For this operation we recommend our SuperV drills respectively. Thanks to a 140° point angle and a m7 tolerance on diameter these drills are especially suitable for this machining task.
3. Entry of deep hole drill in the pilot hole at a speed of approx. 300 rev./min and with a feed rate of approx. 500 mm/min.
4. Turn on coolant pressure and speed.
5. Continuous drilling to complete hole depth without pecking.
6. For through holes with plain - i.e. 90° - exit, reduce feed rate v_f to 50 % approx. 1 mm prior to break-through.
7. For through holes with oblique exit, reduce the feed rate v_f to 40 % approx. 1 mm prior to break-through.
8. After reaching hole depth stop machine spindle and coolant supply, withdrawal with max. 5000 mm/min.

Suitable standard tools for your application can be found from page 18.



1. Operation - Pilot hole

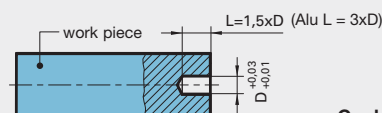

2. Operation - Deep hole drilling

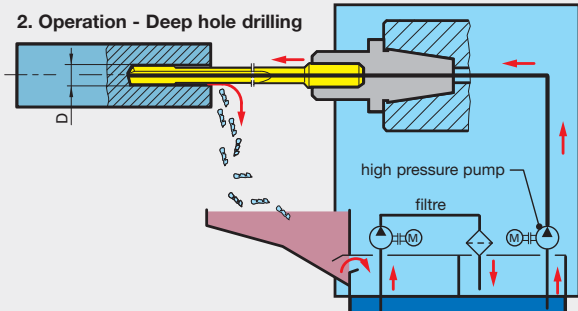

The drilling process on deep hole drilling machines

Where mass production, milling of very deep holes and high quality surface finishes are required, deep-hole drilling machines are used. A nearly endless range of drilling depth becomes available. The gun drill is guided by steady rest bushes. The accordion-like movement of the bushes allows a continuous drilling. „Drilling without pecking“.

Pilot holes are not needed, thus reducing time and costs for tool change. Offering a greater drilling depth (up to a couple of meters), and at the same time, an excellent drilling quality. High pressure pumps and a coolant filter system guarantee maximum process security.

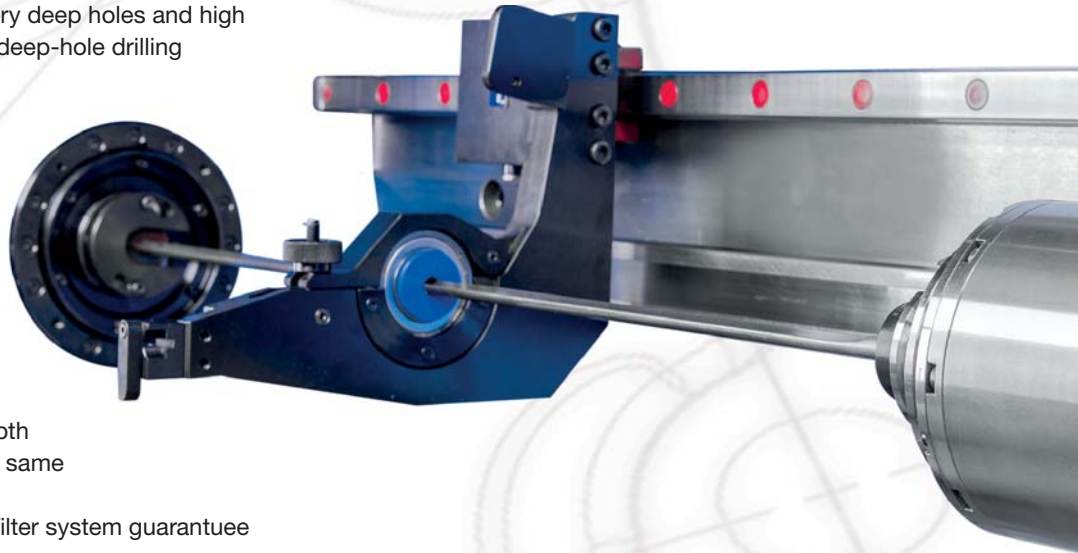

Suitable standard tools for your application can be found from page 44.

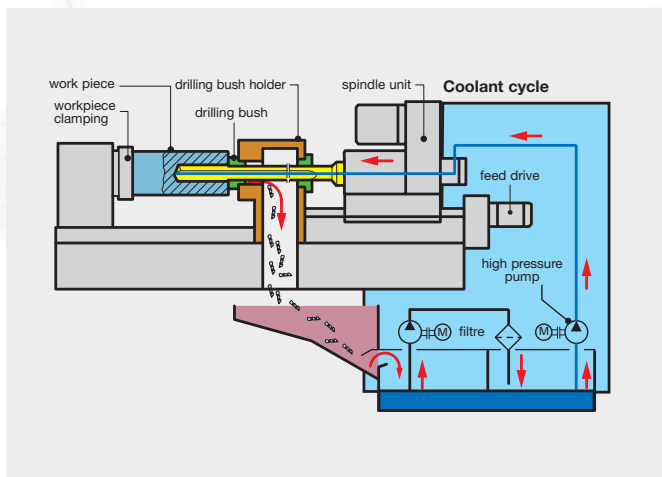

SuperV-NX SuperV-T

THE TWISTED ONE

from diameter 1.4 to 16.0 mm,
for the machining of various steels, stainless materials
or special alloys

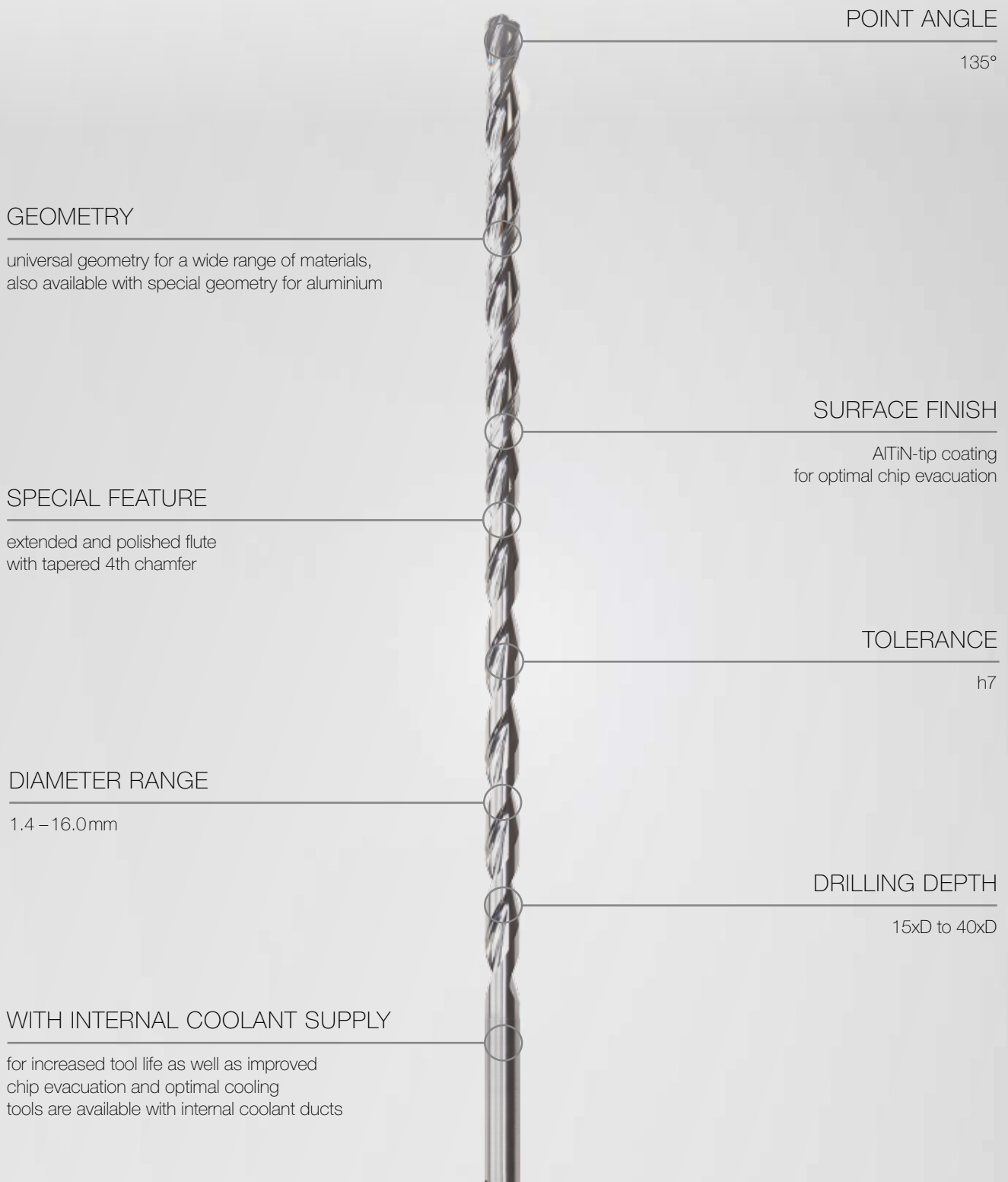

POINT ANGLE

135°

GEOMETRY

universal geometry for a wide range of materials,
also available with special geometry for aluminium

SURFACE FINISH

AlTiN-tip coating
for optimal chip evacuation

SPECIAL FEATURE

extended and polished flute
with tapered 4th chamfer

TOLERANCE

h7

DIAMETER RANGE

1.4 – 16.0mm

DRILLING DEPTH

15xD to 40xD

WITH INTERNAL COOLANT SUPPLY

for increased tool life as well as improved
chip evacuation and optimal cooling
tools are available with internal coolant ducts

P	M	K	N	S	H	Type	Shank form	Drilling depth	Tool material	Surface	Standard	d1/mm	Catalogue no.	Progr. page
---	---	---	---	---	---	------	------------	----------------	---------------	---------	----------	-------	---------------	-------------

SuperV-NX high-performance microdrills with int. coolant



•	•	•	○	○		SuperV-IK-NX	HA	15xD	Solid carbide	AlTiN	Company std.	1.400 - 3.000	51999	18
---	---	---	---	---	--	--------------	----	------	---------------	-------	--------------	---------------	--------------	----

SuperV drills with internal coolant



•	•	•	○	○		SuperV-T	HA	15xD	Solid carbide	AlTiN	Company std.	3.000 - 16.000	51764	19
---	---	---	---	---	--	----------	----	------	---------------	-------	--------------	----------------	--------------	----



•	•	•	○	○		SuperV-T	HA	20xD	Solid carbide	AlTiN	Company std.	3.000 - 16.000	51765	20
---	---	---	---	---	--	----------	----	------	---------------	-------	--------------	----------------	--------------	----



•	•	•	○	○		SuperV-T	HA	25xD	Solid carbide	AlTiN	Company std.	3.000 - 16.000	51766	21
---	---	---	---	---	--	----------	----	------	---------------	-------	--------------	----------------	--------------	----



•	•	•	○	○		SuperV-T	HA	30xD	Solid carbide	AlTiN	Company std.	3.000 - 14.000	51767	22
---	---	---	---	---	--	----------	----	------	---------------	-------	--------------	----------------	--------------	----



•	•	•	○	○		SuperV-T	HA	40xD	Solid carbide	AlTiN	Company std.	3.000 - 10.000	51768	23
---	---	---	---	---	--	----------	----	------	---------------	-------	--------------	----------------	--------------	----

TBE-VHM

THE CONVENTIONAL ONE

universal deep hole drills for a wide range of materials, especially for small diameters, cutting edge and tube made of carbide, bright version particularly suitable for non-ferrous metals

SURFACE FINISH

bright and AlTiN+ coated

TOLERANCE

h5

FLUTE LENGTH

45mm, 80mm, 120mm, 160mm

HEAD FORM G

for universal application

DIAMETER RANGE

1.20mm – 8.00mm

SHANK

HA shanks in
Ø 4.00mm, 10.00mm, 16.00mm

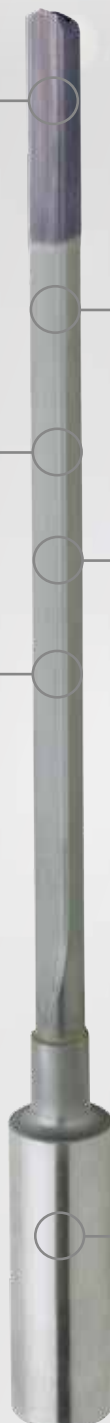

P	M	K	N	S	H	Type	Shank form	Flute length	Tool material	Surface	Standard	d1/mm	Catalogue no.	Progr. page
---	---	---	---	---	---	------	------------	--------------	---------------	---------	----------	-------	---------------	-------------

Gun drills, type TBE-VHM

	○	○	○	●	●	○	TBE-VHM	HA	45.000	Solid carbide	bright	Company std.	1.200 - 3.200	75024	25
	●	○	●	○	○	○	TBE-VHM	HA	45.000	Solid carbide	AlTiN+	Company std.	2.000 - 3.200	55024	26
	○	○	○	●	●	○	TBE-VHM	HA	80.000	Solid carbide	bright	Company std.	1.200 - 5.000	75020	27
	●	○	●	○	○	○	TBE-VHM	HA	80.000	Solid carbide	AlTiN+	Company std.	2.000 - 5.000	55020	28
	○	○	○	●	●	○	TBE-VHM	HA	120.000	Solid carbide	bright	Company std.	1.500 - 5.000	75026	29
	●	○	●	○	○	○	TBE-VHM	HA	120.000	Solid carbide	AlTiN+	Company std.	2.000 - 5.000	55026	30
	○	○	○	●	●	○	TBE-VHM	HA	160.000	Solid carbide	bright	Company std.	1.500 - 8.000	75021	31
	●	○	●	○	○	○	TBE-VHM	HA	160.000	Solid carbide	AlTiN+	Company std.	2.000 - 8.000	55021	32

SuperT-AL

THE DURABLE ONE

high feed rates, suitable for MQL,
made of solid carbide, for universal application

SURFACE FINISH

AlTiN nano

CARBIDE

our own produced universal ultra fine grained
carbide grade

DRILLING DEPTH

25xD, 50xD, 75xD

HEAD FORM G

for universal application

DESIGN

for high feed rates and drilling also with MQL

DIAMETER RANGE

1.00mm – 16.00mm

SHANK FORM

solid carbide shank with tapered MQL end
for shank diameter ≥ 6.0 mm



P	M	K	N	S	H	Type	Shank form	Drilling depth	Tool material	Surface	Standard	d1/mm	Catalogue no.	Progr. page
---	---	---	---	---	---	------	------------	----------------	---------------	---------	----------	-------	---------------	-------------

Gun drills, type SuperT-AL

	•	•	○	○	•	SuperT-Al	HA	25xD	Solid carbide	AlTiN nano	Company std.	1.000 - 16.000	55027	33
	•	•	○	○	•	SuperT-Al	HA	50xD	Solid carbide	AlTiN nano	Company std.	1.191 - 10.000	55028	34
	•	•	○	○	•	SuperT-Al	HA	75xD	Solid carbide	AlTiN nano	Company std.	1.000 - 7.144	55029	35

SuperT-N SuperT-NX

THE CONVENTIONAL ONE WITH BRAZED CARBIDE HEAD

universal gun drills with brazed carbide head in two versions:

- with lateral chip breaker for long-chipping materials
- without chip breaker for alloyed and high alloyed steels

SURFACE FINISH

TiN, TiCN

- TiN with chip breaker for long-chipping materials
- TiCN without chip breaker for alloyed and high alloyed steels

CARBIDE TIPPED

our own produced ultra fine grained universal carbide grade

GEOMETRY

universal geometry for a wide range of materials with and without chip breaker, head form G

DRILLING DEPTH

20xD, 30xD, 40xD, 80xD

TOLERANCE

h5

DIAMETER RANGE

3.97mm – 12.70mm

SHANK FORM

HA shank



P	M	K	N	S	H	Type	Shank form	Drilling depth	Tool material	Surface	Standard	d1/mm	Catalogue no.	Progr. page
---	---	---	---	---	---	------	------------	----------------	---------------	---------	----------	-------	---------------	-------------

Gun drills, type SuperT-N

	●	○	●	○	○	○	SuperT-N	HA	20xD	Carbide	TiN	Company std.	4.000 - 12.000	75018	36
	●	○	●	○	○	○	SuperT-N	HA	30xD	Carbide	TiN	Company std.	4.000 - 12.000	75017	37
	●	○	●	○	○	○	SuperT-N	HA	40xD	Carbide	TiN	Company std.	4.000 - 12.000	75022	38
	●	○	●	○	○	○	SuperT-N	HA	80xD	Carbide	TiN	Company std.	4.950 - 11.950	75023	39

Gun drills, type SuperT-NX

	○	●	○	○	●	○	SuperT-NX	HA	20xD	Carbide	TiCN	Company std.	3.970 - 12.700	55018	40
	○	●	○	○	●	○	SuperT-NX	HA	30xD	Carbide	TiCN	Company std.	3.970 - 12.700	55017	41
	○	●	○	○	●	○	SuperT-NX	HA	40xD	Carbide	TiCN	Company std.	3.970 - 12.700	55022	42
	○	●	○	○	●	○	SuperT-NX	HA	80xD	Carbide	TiCN	Company std.	4.950 - 12.650	55023	43

SuperT-NXL

THE CONVENTIONAL ONE FOR DEEP HOLE DRILLING MACHINES

standard gun drills for universal application,
well balanced range of diameter and tool length,
ex-stock range for customers with limited time, e.g. in mould and die production

SURFACE FINISH

TIN

CARBIDE TIPPED

our own produced ultra fine grained universal
carbide grade

TOTAL LENGTH

800mm, 1200mm, 1600mm, 2000mm

GEOMETRY

universal geometry for a wide range of materials

DIAMETER RANGE

3.00 – 32.00mm

SHANK FORM

suitbale for deep hole drilling machines,
driver Ø 25.00 T3.1



P	M	K	N	S	H	Type	Shank form	Overall length	Tool material	Surface	Standard	d1/mm	Catalogue no.	Progr. page
---	---	---	---	---	---	------	------------	----------------	---------------	---------	----------	-------	---------------	-------------

Gun drills, type SuperT-NXL

	•	○	•	○	○	○	SuperT-NXL TBM-SEH	800.000	Carbide	TiN	Company std.	3.000 - 25.000	65030	45
	•	○	•	○	○	○	SuperT-NXL TBM-SEH	1200.000	Carbide	TiN	Company std.	3.000 - 25.000	65031	46
	•	○	•	○	○	○	SuperT-NXL TBM-SEH	1600.000	Carbide	TiN	Company std.	4.000 - 25.000	65032	47
	•	○	•	○	○	○	SuperT-NXL TBM-SEH	2000.000	Carbide	TiN	Company std.	4.000 - 32.000	65033	48

SuperV drills

SuperV-NX high-performance microdrills with int. coolant



Catalogue no. 51999



P	M	K	N	S	H
●	●	●	○	○	○

Application recommendations page 51

- web thinning $\geq \varnothing 1.400$
- facet point grind
- tip coating
- main cutting edge form straight
- edge preparation
- observe coolant pressure (see diagram "coolant recommendations")

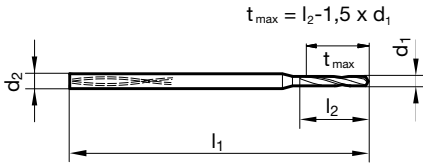

d1 mm	inch	d2 mm	l1 mm	l2 mm
1.400		4.000	62.000	25.000
1.500		4.000	62.000	27.000
1.590	1/16	4.000	62.000	29.000
1.600		4.000	62.000	29.000
1.700		4.000	70.000	31.000
1.800		4.000	70.000	32.000
1.900		4.000	70.000	34.000
1.980	5/64	4.000	70.000	36.000
2.000		4.000	70.000	36.000
2.100		4.000	78.000	38.000
2.200		4.000	78.000	40.000
2.300		4.000	78.000	42.000

d1 mm	inch	d2 mm	l1 mm	l2 mm
2.380	3/32	4.000	78.000	44.000
2.400		4.000	78.000	44.000
2.500		4.000	78.000	45.000
2.600		4.000	87.000	47.000
2.700		4.000	87.000	48.000
2.780	7/64	4.000	87.000	50.000
2.800		4.000	87.000	50.000
2.900		4.000	87.000	52.000
3.000		4.000	87.000	54.000

SuperV drills

SuperV drills with internal coolant



Catalogue no. 51764



P	M	K	N	S	H	Application recommendations page 53
●	●	●	○	○		

- web thinning $\geq \varnothing 3.000$
- tip coating
- relieved cone
- main cutting edge form concave
- optimised flute design
- maximum diameter of coolant ducts
- application in hydraulic chucks
- double margin
- observe coolant pressure (see diagram "coolant recommendations")

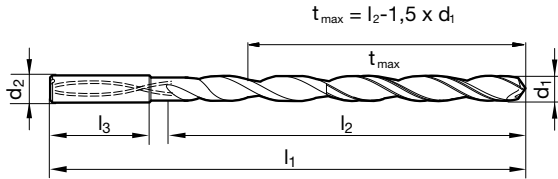

d1		d2	l1	l2	l3
mm	inch	mm	mm	mm	mm
3.000		6.000	95.000	55.000	36.000
3.100		6.000	106.000	66.000	36.000
3.170	1/8	6.000	106.000	66.000	36.000
3.200		6.000	106.000	66.000	36.000
3.300		6.000	106.000	66.000	36.000
3.500		6.000	116.000	76.000	36.000
3.570	9/64	6.000	116.000	76.000	36.000
3.700		6.000	116.000	76.000	36.000
3.800		6.000	116.000	76.000	36.000
3.970	5/32	6.000	116.000	76.000	36.000
4.000		6.000	116.000	76.000	36.000
4.200		6.000	133.000	93.000	36.000
4.300		6.000	133.000	93.000	36.000
4.370	11/64	6.000	133.000	93.000	36.000
4.500		6.000	133.000	93.000	36.000
4.600		6.000	133.000	93.000	36.000
4.760	3/16	6.000	133.000	93.000	36.000
4.800		6.000	133.000	93.000	36.000
5.000		6.000	133.000	93.000	36.000
5.100		6.000	150.000	110.000	36.000
5.160	13/64	6.000	150.000	110.000	36.000
5.410		6.000	150.000	110.000	36.000
5.500		6.000	150.000	110.000	36.000
5.560	7/32	6.000	150.000	110.000	36.000
5.800		6.000	150.000	110.000	36.000
5.950	15/64	6.000	150.000	110.000	36.000
6.000		6.000	150.000	110.000	36.000
6.300		8.000	167.000	127.000	36.000
6.350	1/4	8.000	167.000	127.000	36.000
6.500		8.000	167.000	127.000	36.000
6.750	17/64	8.000	167.000	127.000	36.000
6.800		8.000	167.000	127.000	36.000
7.000		8.000	167.000	127.000	36.000
7.140	9/32	8.000	183.000	143.000	36.000
7.500		8.000	183.000	143.000	36.000
7.540	19/64	8.000	183.000	143.000	36.000

d1		d2	l1	l2	l3
mm	inch	mm	mm	mm	mm
7.800		8.000	183.000	143.000	36.000
7.940	5/16	8.000	183.000	143.000	36.000
8.000		8.000	183.000	143.000	36.000
8.330	21/64	10.000	204.000	160.000	40.000
8.500		10.000	204.000	160.000	40.000
8.730	11/32	10.000	204.000	160.000	40.000
8.800		10.000	204.000	160.000	40.000
9.000		10.000	204.000	160.000	40.000
9.130	23/64	10.000	221.000	177.000	40.000
9.520	3/8	10.000	221.000	177.000	40.000
9.800		10.000	221.000	177.000	40.000
9.920	25/64	10.000	221.000	177.000	40.000
10.000		10.000	221.000	177.000	40.000
10.320	13/32	12.000	247.000	198.000	45.000
10.500		12.000	247.000	198.000	45.000
10.720	27/64	12.000	247.000	198.000	45.000
11.000		12.000	247.000	198.000	45.000
11.110	7/16	12.000	263.000	214.000	45.000
11.510	29/64	12.000	263.000	214.000	45.000
11.800		12.000	263.000	214.000	45.000
11.910	15/32	12.000	263.000	214.000	45.000
12.000		12.000	263.000	214.000	45.000
12.300	31/64	14.000	297.000	248.000	45.000
12.500		14.000	297.000	248.000	45.000
12.700	1/2	14.000	297.000	248.000	45.000
13.000		14.000	297.000	248.000	45.000
13.100	33/64	14.000	297.000	248.000	45.000
13.490	17/32	14.000	297.000	248.000	45.000
13.890	35/64	14.000	297.000	248.000	45.000
14.000		14.000	297.000	248.000	45.000
14.290	9/16	16.000	333.000	281.000	48.000
15.000		16.000	333.000	281.000	48.000
15.870	5/8	16.000	333.000	281.000	48.000
16.000		16.000	333.000	281.000	48.000

SuperV drills

SuperV drills with internal coolant



Catalogue no. 51765



P	M	K	N	S	H
●	●	●	○	○	

Application recommendations page 53

- web thinning $\geq \varnothing 3.000$
- relieved cone
- tip coating
- main cutting edge form concave
- optimised flute design
- maximum diameter of coolant ducts
- application in hydraulic chucks
- double margin
- observe coolant pressure (see diagram "coolant recommendations")

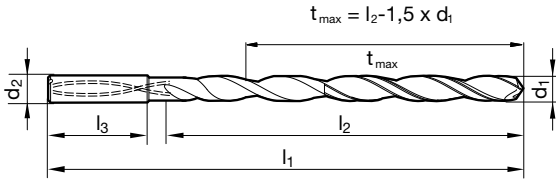

d1		d2	l1	l2	l3
mm	inch	mm	mm	mm	mm
3.000		6.000	110.000	70.000	36.000
3.100		6.000	123.000	83.000	36.000
3.200		6.000	123.000	83.000	36.000
3.300		6.000	123.000	83.000	36.000
3.500		6.000	136.000	96.000	36.000
3.570	9/64	6.000	136.000	96.000	36.000
3.700		6.000	136.000	96.000	36.000
3.800		6.000	136.000	96.000	36.000
3.970	5/32	6.000	136.000	96.000	36.000
4.000		6.000	136.000	96.000	36.000
4.200		6.000	158.000	118.000	36.000
4.300		6.000	158.000	118.000	36.000
4.370	11/64	6.000	158.000	118.000	36.000
4.500		6.000	158.000	118.000	36.000
4.600		6.000	158.000	118.000	36.000
4.760	3/16	6.000	158.000	118.000	36.000
4.800		6.000	158.000	118.000	36.000
5.000		6.000	158.000	118.000	36.000
5.100		6.000	180.000	140.000	36.000
5.160	13/64	6.000	180.000	140.000	36.000
5.410		6.000	180.000	140.000	36.000
5.500		6.000	180.000	140.000	36.000
5.560	7/32	6.000	180.000	140.000	36.000
5.800		6.000	180.000	140.000	36.000
5.950	15/64	6.000	180.000	140.000	36.000
6.000		6.000	180.000	140.000	36.000
6.350	1/4	8.000	202.000	162.000	36.000
6.500		8.000	202.000	162.000	36.000
6.750	17/64	8.000	202.000	162.000	36.000
6.800		8.000	202.000	162.000	36.000
7.000		8.000	202.000	162.000	36.000
7.140	9/32	8.000	223.000	183.000	36.000
7.500		8.000	223.000	183.000	36.000
7.540	19/64	8.000	223.000	183.000	36.000
7.800		8.000	223.000	183.000	36.000
7.940	5/16	8.000	223.000	183.000	36.000

d1		d2	l1	l2	l3
mm	inch	mm	mm	mm	mm
8.000		8.000	223.000	183.000	36.000
8.330	21/64	10.000	249.000	205.000	40.000
8.500		10.000	249.000	205.000	40.000
8.730	11/32	10.000	249.000	205.000	40.000
8.800		10.000	249.000	205.000	40.000
9.000		10.000	249.000	205.000	40.000
9.130	23/64	10.000	271.000	227.000	40.000
9.520	3/8	10.000	271.000	227.000	40.000
10.000		10.000	271.000	227.000	40.000
10.200		12.000	302.000	253.000	45.000
10.320	13/32	12.000	302.000	253.000	45.000
10.500		12.000	302.000	253.000	45.000
10.720	27/64	12.000	302.000	253.000	45.000
11.000		12.000	302.000	253.000	45.000
11.110	7/16	12.000	323.000	274.000	45.000
11.510	29/64	12.000	323.000	274.000	45.000
11.800		12.000	323.000	274.000	45.000
11.910	15/32	12.000	323.000	274.000	45.000
12.000		12.000	323.000	274.000	45.000
12.500		14.000	367.000	318.000	45.000
12.700	1/2	14.000	367.000	318.000	45.000
13.490	17/32	14.000	367.000	318.000	45.000
14.000		14.000	367.000	318.000	45.000
14.290	9/16	16.000	413.000	361.000	48.000
15.000		16.000	413.000	361.000	48.000
15.870	5/8	16.000	413.000	361.000	48.000
16.000		16.000	413.000	361.000	48.000

SuperV drills

SuperV drills with internal coolant



Catalogue no. 51766

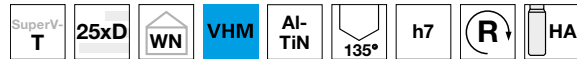

P	M	K	N	S	H	Application recommendations page 53
●	●	●	○	○		

- web thinning $\geq \varnothing 3.000$
- relieved cone
- tip coating
- main cutting edge form concave
- optimised flute design
- maximum diameter of coolant ducts
- application in hydraulic chucks
- double margin
- observe coolant pressure (see diagram "coolant recommendations")

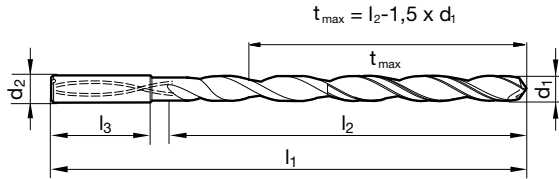

d1		d2	l1	l2	l3
mm	inch	mm	mm	mm	mm
3.000		6.000	125.000	85.000	36.000
3.100		6.000	141.000	101.000	36.000
3.200		6.000	141.000	101.000	36.000
3.300		6.000	141.000	101.000	36.000
3.500		6.000	156.000	116.000	36.000
3.570	9/64	6.000	156.000	116.000	36.000
3.700		6.000	156.000	116.000	36.000
3.800		6.000	156.000	116.000	36.000
3.970	5/32	6.000	156.000	116.000	36.000
4.000		6.000	156.000	116.000	36.000
4.200		6.000	183.000	143.000	36.000
4.300		6.000	183.000	143.000	36.000
4.370	11/64	6.000	183.000	143.000	36.000
4.500		6.000	183.000	143.000	36.000
4.600		6.000	183.000	143.000	36.000
4.760	3/16	6.000	183.000	143.000	36.000
4.800		6.000	183.000	143.000	36.000
5.000		6.000	183.000	143.000	36.000
5.100		6.000	210.000	170.000	36.000
5.160	13/64	6.000	210.000	170.000	36.000
5.410		6.000	210.000	170.000	36.000
5.500		6.000	210.000	170.000	36.000
5.560	7/32	6.000	210.000	170.000	36.000
5.800		6.000	210.000	170.000	36.000
5.950	15/64	6.000	210.000	170.000	36.000
6.000		6.000	210.000	170.000	36.000
6.300		8.000	237.000	197.000	36.000
6.350	1/4	8.000	237.000	197.000	36.000
6.500		8.000	237.000	197.000	36.000
6.750	17/64	8.000	237.000	197.000	36.000

d1		d2	l1	l2	l3
mm	inch	mm	mm	mm	mm
6.800		8.000	237.000	197.000	36.000
7.000		8.000	237.000	197.000	36.000
7.140	9/32	8.000	263.000	223.000	36.000
7.500		8.000	263.000	223.000	36.000
7.540	19/64	8.000	263.000	223.000	36.000
7.940	5/16	8.000	263.000	223.000	36.000
8.000		8.000	263.000	223.000	36.000
8.330	21/64	10.000	294.000	250.000	40.000
8.500		10.000	294.000	250.000	40.000
8.730	11/32	10.000	294.000	250.000	40.000
8.800		10.000	294.000	250.000	40.000
9.000		10.000	294.000	250.000	40.000
9.130	23/64	10.000	321.000	277.000	40.000
9.520	3/8	10.000	321.000	277.000	40.000
10.000		10.000	321.000	277.000	40.000
10.720	27/64	12.000	359.000	310.000	45.000
11.000		12.000	359.000	310.000	45.000
11.110	7/16	12.000	386.000	337.000	45.000
12.000		12.000	386.000	337.000	45.000
12.300	31/64	14.000	437.000	388.000	45.000
12.700	1/2	14.000	437.000	388.000	45.000
13.000		14.000	437.000	388.000	45.000
13.100	33/64	14.000	437.000	388.000	45.000
13.490	17/32	14.000	437.000	388.000	45.000
13.890	35/64	14.000	437.000	388.000	45.000
14.000		14.000	437.000	388.000	45.000
14.290	9/16	16.000	493.000	441.000	48.000
15.000		16.000	493.000	441.000	48.000
15.870	5/8	16.000	493.000	441.000	48.000
16.000		16.000	493.000	441.000	48.000

SuperV drills

SuperV drills with internal coolant



Catalogue no. 51767

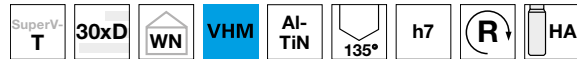

P	M	K	N	S	H	Application recommendations page 53
●	●	●	○	○		

- web thinning $\geq \varnothing 3.000$
- relieved cone
- tip coating
- main cutting edge form concave
- optimised flute design
- maximum diameter of coolant ducts
- application in hydraulic chucks
- double margin
- observe coolant pressure (see diagram "coolant recommendations")

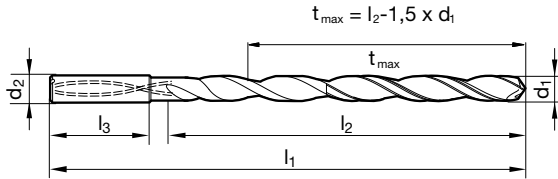

d1		d2	l1	l2	l3
mm	inch	mm	mm	mm	mm
3.000		6.000	140.000	100.000	36.000
3.100		6.000	158.000	118.000	36.000
3.200		6.000	158.000	118.000	36.000
3.300		6.000	158.000	118.000	36.000
3.500		6.000	176.000	136.000	36.000
3.570	9/64	6.000	176.000	136.000	36.000
3.700		6.000	176.000	136.000	36.000
3.800		6.000	176.000	136.000	36.000
3.970	5/32	6.000	176.000	136.000	36.000
4.000		6.000	176.000	136.000	36.000
4.200		6.000	208.000	168.000	36.000
4.370	11/64	6.000	208.000	168.000	36.000
4.500		6.000	208.000	168.000	36.000
4.760	3/16	6.000	208.000	168.000	36.000
5.000		6.000	208.000	168.000	36.000
5.100		6.000	240.000	200.000	36.000
5.160	13/64	6.000	240.000	200.000	36.000
5.410		6.000	240.000	200.000	36.000
5.500		6.000	240.000	200.000	36.000
5.560	7/32	6.000	240.000	200.000	36.000
5.950	15/64	6.000	240.000	200.000	36.000
6.000		6.000	240.000	200.000	36.000
6.300		8.000	272.000	232.000	36.000
6.350	1/4	8.000	272.000	232.000	36.000
6.500		8.000	272.000	232.000	36.000
6.750	17/64	8.000	272.000	232.000	36.000
6.800		8.000	272.000	232.000	36.000
7.000		8.000	272.000	232.000	36.000
7.140	9/32	8.000	303.000	263.000	36.000
7.500		8.000	303.000	263.000	36.000

d1		d2	l1	l2	l3
mm	inch	mm	mm	mm	mm
7.540	19/64	8.000	303.000	263.000	36.000
7.940	5/16	8.000	303.000	263.000	36.000
8.000		8.000	303.000	263.000	36.000
8.330	21/64	10.000	339.000	295.000	40.000
8.500		10.000	339.000	295.000	40.000
8.730	11/32	10.000	339.000	295.000	40.000
8.800		10.000	339.000	295.000	40.000
9.000		10.000	339.000	295.000	40.000
9.130	23/64	10.000	371.000	327.000	40.000
9.520	3/8	10.000	371.000	327.000	40.000
10.000		10.000	371.000	327.000	40.000
10.320	13/32	12.000	412.000	363.000	45.000
10.720	27/64	12.000	412.000	363.000	45.000
11.000		12.000	412.000	363.000	45.000
11.110	7/16	12.000	443.000	394.000	45.000
11.510	29/64	12.000	443.000	394.000	45.000
11.910	15/32	12.000	443.000	394.000	45.000
12.000		12.000	443.000	394.000	45.000
12.300	31/64	14.000	507.000	458.000	45.000
12.700	1/2	14.000	507.000	458.000	45.000
13.000		14.000	507.000	458.000	45.000
13.100	33/64	14.000	507.000	458.000	45.000
13.490	17/32	14.000	507.000	458.000	45.000
13.890	35/64	14.000	507.000	458.000	45.000
14.000		14.000	507.000	458.000	45.000

SuperV drills

SuperV drills with internal coolant



Catalogue no. 51768



P	M	K	N	S	H	Application recommendations page 53
●	●	●	○	○		

- web thinning $\geq \varnothing 3.000$
- relieved cone
- tip coating
- main cutting edge form concave
- optimised flute design
- maximum diameter of coolant ducts
- application in hydraulic chucks
- double margin
- observe coolant pressure (see diagram "coolant recommendations")

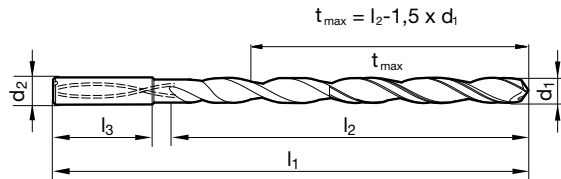

d1 mm	inch	d2 mm	l1 mm	l2 mm	l3 mm
3.000		6.000	170.000	130.000	36.000
3.100		6.000	193.000	153.000	36.000
3.170	1/8	6.000	193.000	153.000	36.000
3.200		6.000	193.000	153.000	36.000
3.300		6.000	193.000	153.000	36.000
3.500		6.000	193.000	153.000	36.000
3.800		6.000	216.000	176.000	36.000
3.970	5/32	6.000	216.000	176.000	36.000
4.000		6.000	216.000	176.000	36.000
4.200		6.000	238.000	198.000	36.000
4.500		6.000	238.000	198.000	36.000
4.760	3/16	6.000	258.000	218.000	36.000
5.000		6.000	258.000	218.000	36.000
5.100		6.000	280.000	240.000	36.000
5.500		6.000	280.000	240.000	36.000
5.560	7/32	6.000	300.000	260.000	36.000
6.000		6.000	300.000	260.000	36.000
6.300		8.000	322.000	282.000	36.000

d1 mm	inch	d2 mm	l1 mm	l2 mm	l3 mm
6.350	1/4	8.000	322.000	282.000	36.000
6.500		8.000	322.000	282.000	36.000
6.800		8.000	342.000	302.000	36.000
7.000		8.000	342.000	302.000	36.000
7.140	9/32	8.000	363.000	323.000	36.000
7.500		8.000	363.000	323.000	36.000
8.000		8.000	383.000	343.000	36.000
8.500		10.000	409.000	365.000	40.000
9.000		10.000	429.000	386.000	40.000
10.000		10.000	471.000	427.000	40.000



HSS-CO Spiral deep hole drills

- up to 20xD drilling depth without pecking
- new parabolic flute geometry for optimal chip evacuation
- especially suitable for the machining of steel
- available as semi-standard

Single-fluted gun drills

Gun drills, type TBE-VHM



Catalogue no. 75024



P	M	K	N	S	H
○	○	○	●	●	○

Application recommendations page 55

- flute length 45 mm
- head form G
- for universal application

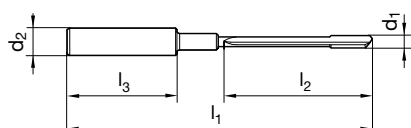

d1 mm	d2 mm	l1 mm	l2 mm	l3 mm	Code no.
1.200	4.000	90.000	45.000	28.000	1.200
1.500	4.000	90.000	45.000	28.000	1.500
1.600	4.000	90.000	45.000	28.000	1.600
2.000	4.000	90.000	45.000	28.000	2.000
2.500	10.000	100.000	45.000	40.000	2.500
2.700	10.000	100.000	45.000	40.000	2.700
3.000	10.000	100.000	45.000	40.000	3.000
3.200	10.000	100.000	45.000	40.000	3.200

Single-fluted gun drills

Gun drills, type TBE-VHM



Catalogue no. 55024



P	M	K	N	S	H
●	○	●	○	○	○

Application recommendations page 55

- flute length 45 mm
- head form G
- for alloyed and high alloyed steels

The conventional one

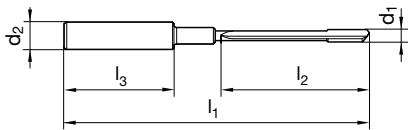

d1 mm	d2 mm	l1 mm	l2 mm	l3 mm	Code no.
2.000	4.000	90.000	45.000	28.000	2.000
2.500	10.000	100.000	45.000	40.000	2.500
2.700	10.000	100.000	45.000	40.000	2.700
3.000	10.000	100.000	45.000	40.000	3.000
3.200	10.000	100.000	45.000	40.000	3.200

Single-fluted gun drills

Gun drills, type TBE-VHM



Catalogue no. 75020



P	M	K	N	S	H
○	○	○	●	●	○

Application recommendations page 55

- flute length 80 mm
- head form G
- for universal application

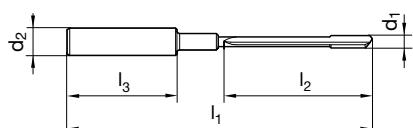

d1 mm	d2 mm	l1 mm	l2 mm	l3 mm	Code no.
1.200	4.000	125.000	80.000	28.000	1.200
1.500	4.000	125.000	80.000	28.000	1.500
1.600	4.000	125.000	80.000	28.000	1.600
2.000	4.000	125.000	80.000	28.000	2.000
2.500	10.000	135.000	80.000	40.000	2.500
2.700	10.000	135.000	80.000	40.000	2.700
3.000	10.000	135.000	80.000	40.000	3.000
3.200	10.000	135.000	80.000	40.000	3.200
3.500	10.000	135.000	80.000	40.000	3.500
4.000	10.000	135.000	80.000	40.000	4.000
4.200	10.000	135.000	80.000	40.000	4.200
4.500	10.000	135.000	80.000	40.000	4.500
5.000	10.000	135.000	80.000	40.000	5.000

Single-fluted gun drills

Gun drills, type TBE-VHM



Catalogue no. 55020



P	M	K	N	S	H
●	○	●	○	○	○

Application recommendations page 55

- flute length 80 mm
- head form G
- for alloyed and high alloyed steels

The conventional one

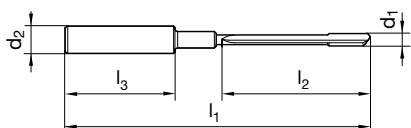

d1 mm	d2 mm	l1 mm	l2 mm	l3 mm	Code no.
2.000	4.000	125.000	80.000	28.000	2.000
2.500	10.000	135.000	80.000	40.000	2.500
2.700	10.000	135.000	80.000	40.000	2.700
3.000	10.000	135.000	80.000	40.000	3.000
3.200	10.000	135.000	80.000	40.000	3.200
3.500	10.000	135.000	80.000	40.000	3.500
4.000	10.000	135.000	80.000	40.000	4.000
4.200	10.000	135.000	80.000	40.000	4.200
4.500	10.000	135.000	80.000	40.000	4.500
5.000	10.000	135.000	80.000	40.000	5.000

Single-fluted gun drills

Gun drills, type TBE-VHM



Catalogue no. 75026



P	M	K	N	S	H
○	○	○	●	●	○

Application recommendations page 55

- flute length 120 mm
- head form G
- for universal application

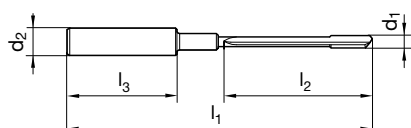

d1 mm	d2 mm	l1 mm	l2 mm	l3 mm	Code no.
1.500	4.000	165.000	120.000	28.000	1.500
1.600	4.000	165.000	120.000	28.000	1.600
2.000	4.000	165.000	120.000	28.000	2.000
2.500	10.000	175.000	120.000	40.000	2.500
2.700	10.000	175.000	120.000	40.000	2.700
3.000	10.000	175.000	120.000	40.000	3.000
3.200	10.000	175.000	120.000	40.000	3.200
3.500	10.000	175.000	120.000	40.000	3.500
4.000	10.000	175.000	120.000	40.000	4.000
4.200	10.000	175.000	120.000	40.000	4.200
4.500	10.000	175.000	120.000	40.000	4.500
5.000	10.000	175.000	120.000	40.000	5.000

Single-fluted gun drills

Gun drills, type TBE-VHM



Catalogue no. 55026



P	M	K	N	S	H
●	○	●	○	○	○

Application recommendations page 55

- flute length 120 mm
- head form G
- for alloyed and high alloyed steels

The conventional one

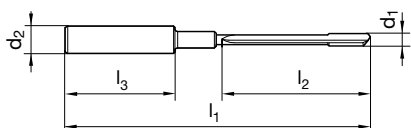

d1 mm	d2 mm	l1 mm	l2 mm	l3 mm	Code no.
2.000	4.000	165.000	120.000	28.000	2.000
2.500	10.000	175.000	120.000	40.000	2.500
2.700	10.000	175.000	120.000	40.000	2.700
3.000	10.000	175.000	120.000	40.000	3.000
3.200	10.000	175.000	120.000	40.000	3.200
3.500	10.000	175.000	120.000	40.000	3.500
4.000	10.000	175.000	120.000	40.000	4.000
4.200	10.000	175.000	120.000	40.000	4.200
4.500	10.000	175.000	120.000	40.000	4.500
5.000	10.000	175.000	120.000	40.000	5.000

Single-fluted gun drills

Gun drills, type TBE-VHM



Catalogue no. 75021



P	M	K	N	S	H
○	○	○	●	●	○

Application recommendations page 55

- flute length 160 mm
- head form G
- for universal application

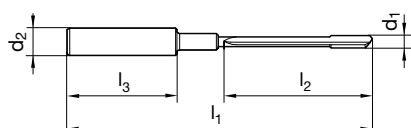

d1 mm	d2 mm	l1 mm	l2 mm	l3 mm	Code no.
1.500	4.000	205.000	160.000	28.000	1.500
1.600	4.000	205.000	160.000	28.000	1.600
2.000	4.000	205.000	160.000	28.000	2.000
2.500	10.000	215.000	160.000	40.000	2.500
2.700	10.000	215.000	160.000	40.000	2.700
3.000	10.000	215.000	160.000	40.000	3.000
3.200	10.000	215.000	160.000	40.000	3.200
3.500	10.000	215.000	160.000	40.000	3.500
4.000	10.000	215.000	160.000	40.000	4.000
4.200	10.000	215.000	160.000	40.000	4.200
4.500	10.000	215.000	160.000	40.000	4.500
5.000	10.000	215.000	160.000	40.000	5.000
6.000	16.000	225.000	160.000	48.000	6.000
8.000	16.000	225.000	160.000	48.000	8.000

Single-fluted gun drills

Gun drills, type TBE-VHM



Catalogue no. 55021



P	M	K	N	S	H
●	○	●	○	○	○

Application recommendations page 55

- flute length 160 mm
- head form G
- for alloyed and high alloyed steels

The conventional one

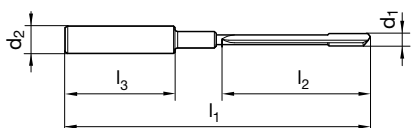

d1 mm	d2 mm	l1 mm	l2 mm	l3 mm	Code no.
2.000	4.000	205.000	160.000	28.000	2.000
2.500	10.000	215.000	160.000	40.000	2.500
2.700	10.000	215.000	160.000	40.000	2.700
3.000	10.000	215.000	160.000	40.000	3.000
3.200	10.000	215.000	160.000	40.000	3.200
3.500	10.000	215.000	160.000	40.000	3.500
4.000	10.000	215.000	160.000	40.000	4.000
4.200	10.000	215.000	160.000	40.000	4.200
4.500	10.000	215.000	160.000	40.000	4.500
5.000	10.000	215.000	160.000	40.000	5.000
6.000	16.000	225.000	160.000	48.000	6.000
8.000	16.000	225.000	160.000	48.000	8.000

Single-fluted gun drills

Gun drills, type SuperT-AL



Catalogue no. 55027



P	M	K	N	S	H
●	●	○	○	●	●

Application recommendations page 55

- head form G
- solid carbide shank with MQL shank end
- for universal application

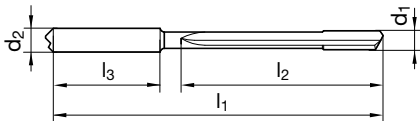

d1 mm	d2 mm	l1 mm	l2 mm	l3 mm	Code no.
1.000	3.000	65.000	32.000	28.000	1.000
1.191	3.000	70.000	39.000	28.000	1.190
1.500	4.000	80.000	49.000	28.000	1.500
2.000	4.000	95.000	65.000	28.000	2.000
2.381	4.000	100.000	70.000	28.000	2.380
2.500	4.000	115.000	85.000	28.000	2.500
2.778	4.000	115.000	85.000	28.000	2.780
3.000	6.000	145.000	105.000	36.000	3.000
3.175	6.000	145.000	105.000	36.000	3.170
3.500	6.000	145.000	105.000	36.000	3.500
3.969	6.000	160.000	120.000	36.000	3.970
4.000	6.000	160.000	120.000	36.000	4.000
5.000	6.000	220.000	180.000	36.000	5.000
5.556	6.000	220.000	180.000	36.000	5.560
6.000	6.000	220.000	180.000	36.000	6.000
6.350	8.000	260.000	210.000	36.000	6.350
6.500	8.000	260.000	210.000	36.000	6.500
7.000	8.000	260.000	210.000	36.000	7.000
7.144	8.000	285.000	240.000	36.000	7.140
8.000	8.000	285.000	240.000	36.000	8.000
9.000	10.000	350.000	300.000	40.000	9.000
10.000	10.000	350.000	300.000	40.000	10.000
11.000	12.000	420.000	360.000	45.000	11.000
11.113	12.000	420.000	360.000	45.000	11.113
12.000	12.000	420.000	360.000	45.000	12.000
12.700	14.000	455.000	396.000	45.000	12.700
14.000	14.000	500.000	437.000	45.000	14.000
15.000	16.000	535.000	468.000	48.000	15.000
15.875	16.000	560.000	495.000	48.000	15.875
16.000	16.000	565.000	499.000	48.000	16.000

The durable one

Single-fluted gun drills

Gun drills, type SuperT-AL



Catalogue no. 55028



P	M	K	N	S	H
●	●	○	○	●	

Application recommendations page 55

- head form G
- solid carbide shank with MQL shank end
- for universal application

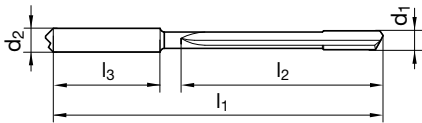

d1 mm	d2 mm	l1 mm	l2 mm	l3 mm	Code no.
1.191	3.000	100.000	68.000	28.000	1.190
2.000	4.000	145.000	115.000	28.000	2.000
2.381	4.000	160.000	130.000	28.000	2.380
2.500	4.000	185.000	155.000	28.000	2.500
2.778	4.000	185.000	155.000	28.000	2.780
3.000	6.000	230.000	190.000	36.000	3.000
3.175	6.000	230.000	190.000	36.000	3.170
3.500	6.000	230.000	190.000	36.000	3.500
3.969	6.000	260.000	220.000	36.000	3.970
4.000	6.000	260.000	220.000	36.000	4.000
5.000	6.000	370.000	330.000	36.000	5.000
5.556	6.000	370.000	330.000	36.000	5.560
6.000	6.000	370.000	330.000	36.000	6.000
6.350	8.000	430.000	385.000	36.000	6.350
6.500	8.000	430.000	385.000	36.000	6.500
7.000	8.000	430.000	385.000	36.000	7.000
7.144	8.000	485.000	440.000	36.000	7.140
8.000	8.000	485.000	440.000	36.000	8.000
9.000	10.000	555.000	506.000	40.000	9.000
10.000	10.000	615.000	562.000	40.000	10.000

The durable one

Single-fluted gun drills

Gun drills, type SuperT-AL



Catalogue no. 55029



Application recommendations page 55

- head form G
- solid carbide shank with MQL shank end
- for universal application

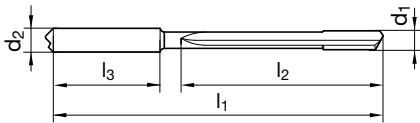

d1 mm	d2 mm	l1 mm	l2 mm	l3 mm	Code no.
1.000	3.000	115.000	82.000	28.000	1.000
1.191	3.000	130.000	98.000	28.000	1.190
1.500	4.000	155.000	124.000	28.000	1.500
1.588	4.000	165.000	131.000	28.000	1.590
1.984	4.000	195.000	163.000	28.000	1.980
2.000	4.000	195.000	165.000	28.000	2.000
2.381	4.000	220.000	190.000	28.000	2.380
2.500	4.000	255.000	220.000	28.000	2.500
2.778	4.000	255.000	220.000	28.000	2.780
3.000	6.000	290.000	274.000	36.000	3.000
3.175	6.000	320.000	280.000	36.000	3.170
3.500	6.000	320.000	280.000	36.000	3.500
3.969	6.000	360.000	320.000	36.000	3.970
4.000	6.000	360.000	320.000	36.000	4.000
5.000	6.000	450.000	406.000	36.000	5.000
5.556	6.000	525.000	485.000	36.000	5.560
6.000	6.000	525.000	485.000	36.000	6.000
6.350	8.000	560.000	516.000	36.000	6.350
6.500	8.000	575.000	528.000	36.000	6.500
6.747	8.000	595.000	548.000	36.000	6.750
7.000	8.000	615.000	568.000	36.000	7.000
7.144	8.000	625.000	580.000	36.000	7.140

The durable one

Single-fluted gun drills

Gun drills, type SuperT-N



Catalogue no. 75018



P	M	K	N	S	H
●	○	●	○	○	○

Application
recommendations
page 55

- with lateral chip breaker
- head form G

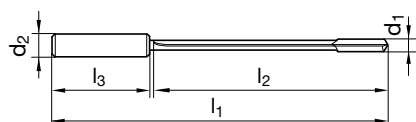

d1 mm	d2 mm	l1 mm	l2 mm	l3 mm	Code no.
4.000	12.000	150.000	100.000	45.000	4.000
4.200	12.000	160.000	110.000	45.000	4.200
4.500	12.000	170.000	120.000	45.000	4.500
5.000	16.000	180.000	130.000	48.000	5.000
5.500	16.000	190.000	140.000	48.000	5.500
6.000	16.000	210.000	160.000	48.000	6.000
6.500	16.000	220.000	170.000	48.000	6.500
7.000	16.000	235.000	185.000	48.000	7.000
8.000	16.000	260.000	210.000	48.000	8.000
9.000	16.000	280.000	230.000	48.000	9.000
10.000	20.000	320.000	260.000	50.000	10.000
12.000	20.000	370.000	310.000	50.000	12.000

The conventional one
with brazed carbide head

Single-fluted gun drills

Gun drills, type SuperT-N



Catalogue no. 75017



P	M	K	N	S	H
●	○	●	○	○	○

Application recommendations page 55

- with lateral chip breaker
- head form G

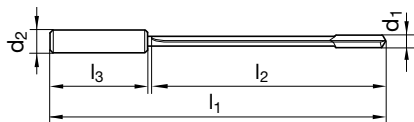

d1 mm	d2 mm	l1 mm	l2 mm	l3 mm	Code no.
4.000	12.000	200.000	155.000	45.000	4.000
4.200	12.000	210.000	165.000	45.000	4.200
4.500	12.000	220.000	175.000	45.000	4.500
5.000	16.000	230.000	182.000	48.000	5.000
5.500	16.000	245.000	197.000	48.000	5.500
6.000	16.000	260.000	212.000	48.000	6.000
6.500	16.000	275.000	227.000	48.000	6.500
7.000	16.000	290.000	242.000	48.000	7.000
8.000	16.000	320.000	272.000	48.000	8.000
9.000	16.000	350.000	302.000	48.000	9.000
10.000	20.000	400.000	350.000	50.000	10.000
12.000	20.000	450.000	400.000	50.000	12.000

The conventional one with brazed carbide head

Single-fluted gun drills

Gun drills, type SuperT-N



Catalogue no. 75022



P	M	K	N	S	H
●	○	●	○	○	○

Application recommendations page 55

- with lateral chip breaker
- head form G

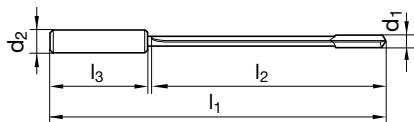

d1 mm	d2 mm	l1 mm	l2 mm	l3 mm	Code no.
4.000	12.000	230.000	185.000	45.000	4.000
4.200	12.000	240.000	195.000	45.000	4.200
4.500	12.000	250.000	205.000	45.000	4.500
5.000	16.000	280.000	232.000	48.000	5.000
5.500	16.000	300.000	252.000	48.000	5.500
6.000	16.000	320.000	272.000	48.000	6.000
6.500	16.000	340.000	292.000	48.000	6.500
7.000	16.000	370.000	322.000	48.000	7.000
8.000	16.000	420.000	372.000	48.000	8.000
9.000	16.000	450.000	402.000	48.000	9.000
10.000	20.000	510.000	460.000	50.000	10.000
12.000	20.000	600.000	550.000	50.000	12.000

The conventional one with brazed carbide head

Single-fluted gun drills

Gun drills, type SuperT-N



Catalogue no. 75023



P	M	K	N	S	H
●	○	●	○	○	○

Application recommendations page 55

- with lateral chip breaker
- head form G
- maximum drilling depth per tool 40xD, for larger drilling depths first apply drill catalogue no. 75022
- for long-chipping materials

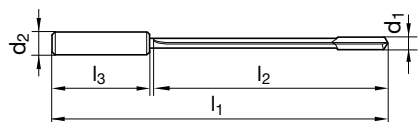

d1 mm	d2 mm	l1 mm	l2 mm	l3 mm	Code no.
4.950	16.000	480.000	432.000	48.000	4.950
5.950	16.000	560.000	512.000	48.000	5.950
7.950	16.000	740.000	692.000	48.000	7.950
9.950	20.000	910.000	860.000	50.000	9.950
11.950	20.000	1080.000	1030.000	50.000	11.950

Single-fluted gun drills

Gun drills, type SuperT-NX



Catalogue no. 55018



P	M	K	N	S	H
○	●	○	○	●	○

Application recommendations page 55

- head form G
- for alloyed and high alloyed steels

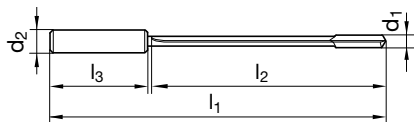

d1 mm	d2 mm	l1 mm	l2 mm	l3 mm	Code no.
3.970	10.000	150.000	100.000	40.000	3.970
4.000	12.000	150.000	100.000	45.000	4.000
5.000	16.000	180.000	130.000	48.000	5.000
5.156	16.000	180.000	130.000	48.000	5.156
6.000	16.000	210.000	160.000	48.000	6.000
6.350	16.000	220.000	170.000	48.000	6.350
7.000	16.000	235.000	185.000	48.000	7.000
7.938	16.000	260.000	210.000	48.000	7.938
8.000	16.000	260.000	210.000	48.000	8.000
9.000	16.000	280.000	230.000	48.000	9.000
9.525	16.000	290.000	240.000	48.000	9.525
10.000	20.000	320.000	260.000	50.000	10.000
11.000	20.000	340.000	290.000	50.000	11.000
11.113	20.000	340.000	290.000	50.000	11.113
12.000	20.000	370.000	310.000	50.000	12.000
12.700	20.000	385.000	330.000	50.000	12.700

The conventional one with brazed carbide head

Single-fluted gun drills

Gun drills, type SuperT-NX



Catalogue no. 55017



P	M	K	N	S	H
○	●	○	○	●	○

Application recommendations page 55

- head form G
- for alloyed and high alloyed steels

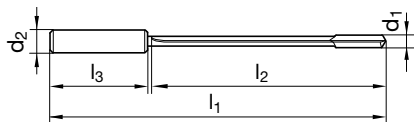

d1 mm	d2 mm	l1 mm	l2 mm	l3 mm	Code no.
3.970	10.000	200.000	155.000	40.000	3.970
4.000	12.000	200.000	155.000	45.000	4.000
5.000	16.000	230.000	182.000	48.000	5.000
5.156	16.000	230.000	182.000	48.000	5.156
6.000	16.000	260.000	212.000	48.000	6.000
6.350	16.000	275.000	227.000	48.000	6.350
7.000	16.000	290.000	242.000	48.000	7.000
7.938	16.000	320.000	272.000	48.000	7.938
8.000	16.000	320.000	272.000	48.000	8.000
9.000	16.000	350.000	302.000	48.000	9.000
9.525	16.000	380.000	330.000	48.000	9.525
10.000	20.000	400.000	350.000	50.000	10.000
11.000	20.000	430.000	380.000	50.000	11.000
11.113	20.000	430.000	380.000	50.000	11.113
12.000	20.000	450.000	400.000	50.000	12.000
12.700	20.000	500.000	450.000	50.000	12.700

The conventional one with brazed carbide head

Single-fluted gun drills

Gun drills, type SuperT-NX



Catalogue no. 55022



P	M	K	N	S	H
○	●	○	○	●	○

Application recommendations page 55

- head form G
- for alloyed and high alloyed steels

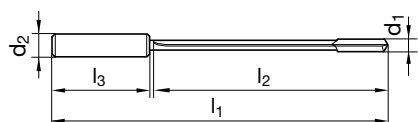

d1 mm	d2 mm	l1 mm	l2 mm	l3 mm	Code no.
3.970	10.000	230.000	185.000	40.000	3.970
4.000	12.000	230.000	185.000	45.000	4.000
5.000	16.000	280.000	232.000	48.000	5.000
5.156	16.000	280.000	232.000	48.000	5.156
6.000	16.000	320.000	272.000	48.000	6.000
6.350	16.000	340.000	292.000	48.000	6.350
7.000	16.000	370.000	322.000	48.000	7.000
7.938	16.000	420.000	372.000	48.000	7.938
8.000	16.000	420.000	372.000	48.000	8.000
9.000	16.000	450.000	402.000	48.000	9.000
9.525	16.000	480.000	432.000	48.000	9.525
10.000	20.000	510.000	460.000	50.000	10.000
11.000	20.000	550.000	500.000	50.000	11.000
11.113	20.000	550.000	500.000	50.000	11.113
12.000	20.000	600.000	550.000	50.000	12.000
12.700	20.000	635.000	585.000	50.000	12.700

The conventional one with brazed carbide head

Single-fluted gun drills

Gun drills, type SuperT-NX



Catalogue no. 55023



P	M	K	N	S	H
○	●	○	○	●	○

Application recommendations page 55

- head form G
- maximum drilling depth per tool 40xD, for larger drilling depths first apply drill catalogue no. 75022
- for alloyed and high alloyed steels

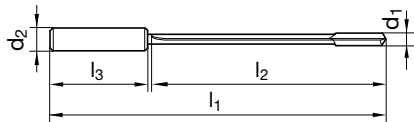

d1 mm	d2 mm	l1 mm	l2 mm	l3 mm	Code no.
4.950	16.000	480.000	432.000	48.000	4.950
5.106	16.000	480.000	432.000	48.000	5.106
5.950	16.000	560.000	512.000	48.000	5.950
6.300	16.000	590.000	542.000	48.000	6.300
6.950	16.000	650.000	602.000	48.000	6.950
7.888	16.000	740.000	692.000	48.000	7.888
7.950	16.000	740.000	692.000	48.000	7.950
8.950	16.000	820.000	772.000	48.000	8.950
9.475	16.000	870.000	822.000	48.000	9.475
9.950	20.000	910.000	860.000	50.000	9.950
10.950	20.000	995.000	945.000	50.000	10.950
11.063	20.000	995.000	945.000	50.000	11.063
11.950	20.000	1080.000	1030.000	50.000	11.950
12.650	20.000	1140.000	1090.000	50.000	12.650

The conventional one with brazed carbide head



SuperT-NXL

- ex-stock range for fast delivery up to a total length of 2000 mm
- driver 3.1 to 3.3 for deep hole drilling machines
- for universal application

Single-fluted gun drills

Gun drills, type SuperT-NXL



Catalogue no. 65030



P	M	K	N	S	H
●	○	●	○	○	○

Application recommendations page 55

- overall length 800 mm
- head form G
- bright rake face for improved chip formation
- for universal application
- only suitable for deep hole drilling machines

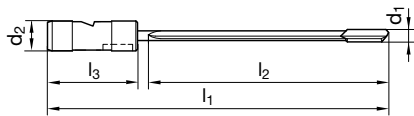

d1 mm	d2 mm	l1 mm	l2 mm	l3 mm	Code no.
3.000	25.000	800.000	700.000	70.000	3.000
4.000	25.000	800.000	700.000	70.000	4.000
5.000	25.000	800.000	700.000	70.000	5.000
6.000	25.000	800.000	700.000	70.000	6.000
7.000	25.000	800.000	700.000	70.000	7.000
8.000	25.000	800.000	700.000	70.000	8.000
9.000	25.000	800.000	700.000	70.000	9.000
10.000	25.000	800.000	700.000	70.000	10.000
11.000	25.000	800.000	700.000	70.000	11.000
11.500	25.000	800.000	700.000	70.000	11.500
12.000	25.000	800.000	700.000	70.000	12.000
13.000	25.000	800.000	700.000	70.000	13.000
14.000	25.000	800.000	700.000	70.000	14.000
15.000	25.000	800.000	700.000	70.000	15.000
16.000	25.000	800.000	700.000	70.000	16.000
17.000	25.000	800.000	700.000	70.000	17.000
18.000	25.000	800.000	700.000	70.000	18.000
19.000	25.000	800.000	700.000	70.000	19.000
20.000	25.000	800.000	700.000	70.000	20.000
21.000	25.000	800.000	700.000	70.000	21.000
22.000	25.000	800.000	700.000	70.000	22.000
23.000	25.000	800.000	700.000	70.000	23.000
24.000	25.000	800.000	700.000	70.000	24.000
25.000	25.000	800.000	700.000	70.000	25.000

The conventional one for deep hole drilling machines

Single-fluted gun drills

Gun drills, type SuperT-NXL



Catalogue no. 65031



P	○	K	○	○	○
●		●			

Application recommendations page 55

- overall length 1200 mm
- head form G
- bright rake face for improved chip formation
- for universal application
- only suitable for deep hole drilling machines

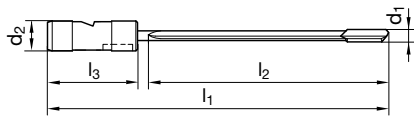

d1 mm	d2 mm	l1 mm	l2 mm	l3 mm	Code no.
3.000	25.000	1200.000	1100.000	70.000	3.000
4.000	25.000	1200.000	1100.000	70.000	4.000
5.000	25.000	1200.000	1100.000	70.000	5.000
6.000	25.000	1200.000	1100.000	70.000	6.000
7.000	25.000	1200.000	1100.000	70.000	7.000
8.000	25.000	1200.000	1100.000	70.000	8.000
9.000	25.000	1200.000	1100.000	70.000	9.000
10.000	25.000	1200.000	1100.000	70.000	10.000
11.000	25.000	1200.000	1100.000	70.000	11.000
11.500	25.000	1200.000	1100.000	70.000	11.500
12.000	25.000	1200.000	1100.000	70.000	12.000
13.000	25.000	1200.000	1100.000	70.000	13.000
14.000	25.000	1200.000	1100.000	70.000	14.000
15.000	25.000	1200.000	1100.000	70.000	15.000
16.000	25.000	1200.000	1100.000	70.000	16.000
17.000	25.000	1200.000	1100.000	70.000	17.000
18.000	25.000	1200.000	1100.000	70.000	18.000
19.000	25.000	1200.000	1100.000	70.000	19.000
20.000	25.000	1200.000	1100.000	70.000	20.000
21.000	25.000	1200.000	1100.000	70.000	21.000
22.000	25.000	1200.000	1100.000	70.000	22.000
23.000	25.000	1200.000	1100.000	70.000	23.000
24.000	25.000	1200.000	1100.000	70.000	24.000
25.000	25.000	1200.000	1100.000	70.000	25.000

The conventional one for deep hole drilling machines

Single-fluted gun drills

Gun drills, type SuperT-NXL



Catalogue no. 65032



P	M	K	N	S	H
●	○	●	○	○	○

Application recommendations page 55

- overall length 1600 mm
- head form G
- bright rake face for improved chip formation
- for universal application
- only suitable for deep hole drilling machines

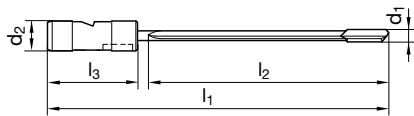

d1 mm	d2 mm	l1 mm	l2 mm	l3 mm	Code no.
4.000	25.000	1600.000	1500.000	70.000	4.000
5.000	25.000	1600.000	1500.000	70.000	5.000
5.500	25.000	1600.000	1500.000	70.000	5.500
6.000	25.000	1600.000	1500.000	70.000	6.000
6.500	25.000	1600.000	1500.000	70.000	6.500
7.000	25.000	1600.000	1500.000	70.000	7.000
7.500	25.000	1600.000	1500.000	70.000	7.500
8.000	25.000	1600.000	1500.000	70.000	8.000
9.000	25.000	1600.000	1500.000	70.000	9.000
9.500	25.000	1600.000	1500.000	70.000	9.500
10.000	25.000	1600.000	1500.000	70.000	10.000
11.000	25.000	1600.000	1500.000	70.000	11.000
11.500	25.000	1600.000	1500.000	70.000	11.500
12.000	25.000	1600.000	1500.000	70.000	12.000
13.000	25.000	1600.000	1500.000	70.000	13.000
14.000	25.000	1600.000	1500.000	70.000	14.000
15.000	25.000	1600.000	1500.000	70.000	15.000
16.000	25.000	1600.000	1500.000	70.000	16.000
17.000	25.000	1600.000	1500.000	70.000	17.000
18.000	25.000	1600.000	1500.000	70.000	18.000
19.000	25.000	1600.000	1500.000	70.000	19.000
20.000	25.000	1600.000	1500.000	70.000	20.000
21.000	25.000	1600.000	1500.000	70.000	21.000
22.000	25.000	1600.000	1500.000	70.000	22.000
23.000	25.000	1600.000	1500.000	70.000	23.000
24.000	25.000	1600.000	1500.000	70.000	24.000
25.000	25.000	1600.000	1500.000	70.000	25.000

The conventional one for deep hole drilling machines

Single-fluted gun drills

Gun drills, type SuperT-NXL



Catalogue no. 65033



P	M	K	N	S	H
●	○	●	○	○	○

Application recommendations page 55

- overall length 2000 mm
- head form G
- bright rake face for improved chip formation
- for universal application
- only suitable for deep hole drilling machines

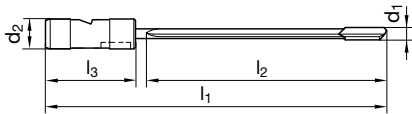

d1 mm	d2 mm	l1 mm	l2 mm	l3 mm	Code no.
4.000	25.000	2000.000	1900.000	70.000	4.000
5.000	25.000	2000.000	1900.000	70.000	5.000
6.000	25.000	2000.000	1900.000	70.000	6.000
7.000	25.000	2000.000	1900.000	70.000	7.000
8.000	25.000	2000.000	1900.000	70.000	8.000
9.000	25.000	2000.000	1900.000	70.000	9.000
10.000	25.000	2000.000	1900.000	70.000	10.000
11.000	25.000	2000.000	1900.000	70.000	11.000
11.500	25.000	2000.000	1900.000	70.000	11.500
12.000	25.000	2000.000	1900.000	70.000	12.000
13.000	25.000	2000.000	1900.000	70.000	13.000
14.000	25.000	2000.000	1900.000	70.000	14.000
15.000	25.000	2000.000	1900.000	70.000	15.000
16.000	25.000	2000.000	1900.000	70.000	16.000
17.000	25.000	2000.000	1900.000	70.000	17.000
18.000	25.000	2000.000	1900.000	70.000	18.000
19.000	25.000	2000.000	1900.000	70.000	19.000
20.000	25.000	2000.000	1900.000	70.000	20.000
21.000	25.000	2000.000	1900.000	70.000	21.000
22.000	25.000	2000.000	1900.000	70.000	22.000
23.000	25.000	2000.000	1900.000	70.000	23.000
24.000	25.000	2000.000	1900.000	70.000	24.000
25.000	25.000	2000.000	1900.000	70.000	25.000
26.000	25.000	2000.000	1895.000	70.000	26.000
27.000	25.000	2000.000	1895.000	70.000	27.000
28.000	25.000	2000.000	1895.000	70.000	28.000
29.000	25.000	2000.000	1895.000	70.000	29.000
30.000	25.000	2000.000	1895.000	70.000	30.000
31.000	25.000	2000.000	1895.000	70.000	31.000
32.000	25.000	2000.000	1895.000	70.000	32.000

The conventional one for deep hole drilling machines



TECHNICAL INFORMATION

SuperV-NX solid carbide micro drills

Application recommendations

		Feed column												
Code-letter	A	B	C	D	E	F	G	H	I	J	K	L	M	
Drill-Ø mm	0,50	0,006	0,012	0,018	0,022	0,030	0,035	0,040	0,045	0,050	0,050	0,055	0,060	0,060
	0,80	0,008	0,016	0,024	0,032	0,040	0,050	0,060	0,070	0,080	0,080	0,090	0,090	
	1,00	0,012	0,022	0,032	0,042	0,060	0,070	0,080	0,090	0,100	0,100	0,110	0,110	
	1,50	0,021	0,036	0,051	0,066	0,090	0,100	0,120	0,130	0,150	0,150	0,160	0,170	
	2,00	0,032	0,052	0,072	0,092	0,120	0,140	0,160	0,180	0,200	0,210	0,220	0,230	
	2,50	0,045	0,070	0,095	0,120	0,150	0,170	0,200	0,220	0,250	0,260	0,270	0,280	
	3,00	0,060	0,090	0,120	0,150	0,180	0,210	0,240	0,270	0,300	0,310	0,330	0,340	

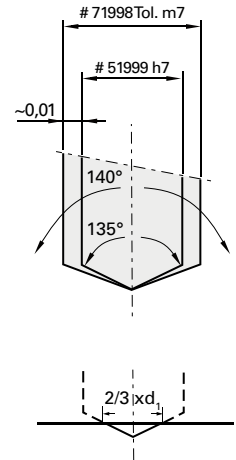

Tools with feed column no. in bold are preferred choices for listed material group.

Security advices: For safety reasons it is very important, that a drill does not exceed a speed of $n = 6000 \text{ rev./min}$ when not supported.

The centrifugal forces could break these long tools before reaching the workpiece surface!

General hints: No play in spindle bearings, alignment accurate tool holders. We recommend the application of hydraulic chucks or shrink fit chucks. We recommend lubrication by soluble oil or neat oil, coolant pressure min. 40 bar.

Pilot drilling

For the application of solid carbide SuperV-NX-drills 15xD we recommend a pilot hole 1xD up to 2xD depth. For this pilot hole, the solid carbide SuperV-NX-drill 4xD is optimally suitable. Its point angle and its diameter tolerance are adapted.

Centering

In order to achieve full performance with SuperV-NX-drills from 8xD drilling depth, we recommend centering. The SuperV-NX-drills up to 4xD, Catalog no. 71998, can be applied for this purpose. The centering diameter should be approximately 2/3xD. Centering can alternatively be made with the NC-drill 142°, Catalog no. 71189.

- Lubricants:**
- cutting oil, highly activated
 - soluble oil (emulsion)
 - without lubricant
 - air only

Material group	Materials examples, new designations (old designation in brackets) Figures in bold = material no. to DIN EN	Tensile strength MPa (N/mm ²)	Hardness	Coolant
General purpose steels	1.0035 S185(St33), 1.0486 P275N(StE285), 1.0345 P235GH(H1), 1.0425 P265GH(H2) 1.0050 E295 (St50-2), 1.0070 E360 (St70-2), 1.8937 P500NH (WStE500)	≤500 >500-850		<input checked="" type="checkbox"/> <input checked="" type="checkbox"/>
Free-cutting steels	1.0718 11SMnPb30 (9SMnPb28), 1.0736 11SMn37 (9SMn36) 1.0727 46S20 (45S20), 1.0728 (60S20), 1.0757 46SPb20 (45SPb20)	≤850 850-1000		<input checked="" type="checkbox"/> <input checked="" type="checkbox"/>
Unalloyed tempering steels	1.0402 C22, 1.1178 C30E (Ck30) 1.0503 C45, 1.1191 C45E (Ck45) 1.0601 C60, 1.1221 C60E (Ck60)	≤ 700 700-850 850-1000		<input checked="" type="checkbox"/> <input checked="" type="checkbox"/> <input checked="" type="checkbox"/>
Alloyed tempering steels	1.5131 50MnSi4, 1.7003 38Cr2, 1.7030 28Cr4 1.5710 36NiCr6, 1.7035 41Cr4, 1.7225 42CrMo4	850-≤1000 1000-1200		<input checked="" type="checkbox"/> <input checked="" type="checkbox"/>
Unalloyed case hardened steels	1.0301 (C10), 1.1121 C10E (Ck10)	≤750		<input checked="" type="checkbox"/>
Alloyed case hardened steels	1.7043 38Cr4 1.5752 15NiCr13 (15NiCr13), 1.7131 16MnCr5, 1.7264 20CrMo5	850-≤1000 1000-1200		<input checked="" type="checkbox"/> <input checked="" type="checkbox"/>
Nitriding steels	1.8504 34CrAl6 1.8519 31CrMoV9, 1.8550 34CrAlNi7	≥850-≤1000 >1000-1200		<input checked="" type="checkbox"/> <input checked="" type="checkbox"/>
Tool steels	1.1750 C75W, 1.2067 102Cr6, 1.2307 29CrMoV9 1.2080 X210Cr12, 1.2083 X42Cr13, 1.2419 105WCr6, 1.2767 X45NiCrMo4	≤850 >850-1000		<input checked="" type="checkbox"/> <input checked="" type="checkbox"/>
High speed steels	1.3243 S 6-5-2-5, 1.3343 S 6-5-2, 1.3344 S 6-5-3	≥650-1000		<input checked="" type="checkbox"/>
Spring steels	1.5026 55Si7, 1.7176 55Cr3, 1.8159 51CrV4 (51CrV4)		≤330 HB	<input checked="" type="checkbox"/>
Hardened steels	-		≤40-48 HRC >48-60 HRC	<input checked="" type="checkbox"/> <input checked="" type="checkbox"/>
Stainless steels, sulphured austenitic	1.4005 X12CrS13, 1.4104 X14CrMoS17, 1.4105 X6CrMoS17, 1.4305 X8CrNiS18-9 1.4301 X5CrNi18-10 (V2A), 1.4541 X6CrNiTi18-10, 1.4571 X6CrNiMoTi 17-12-2 (V4A) 1.4057 X20CrNi 17 2 (X17CrNi16-2), 1.4122 X39CrMo17-1, 1.4521 X2CrMoTi18-2	≤850 ≤850 ≤850		<input checked="" type="checkbox"/> <input checked="" type="checkbox"/> <input checked="" type="checkbox"/>
Cast iron	0.6010 EN-GJL-100(GG10), 0.6020 EN-GJL-200(GG20) 0.6025 EN-GJL-250(GG25), 0.6035 EN-GJL-350(GG35)	850-≤1000 1000-1200		<input checked="" type="checkbox"/> <input checked="" type="checkbox"/>
Spheroidal graphite iron and malleable cast iron	0.7050 EN-GJS-500-7(GGG50), 0.8035 EN-GJMW-350-4(GTW35) 0.7070 EN-GJS-700-2(GGG70), 0.8170 EN-GJMB-700-2(GTS70)		≤240 HB <300 HB	<input checked="" type="checkbox"/> <input checked="" type="checkbox"/>
Chilled cast iron	-		≤350 HB	<input checked="" type="checkbox"/>
New cast iron GGV	EN-GJV250 (GGV25), EN-GJV350 (GGV35) EN-GJV400 (GGV40), EN-GJV500 (GGV50), SiMo6			<input checked="" type="checkbox"/> <input checked="" type="checkbox"/>
New cast iron ADI	EN-GJS-800-8 (ADI800), EN-GJS-1000-5 (ADI1000) EN-GJS-1200-2 (ADI1200), EN-GJS-1400-1 (ADI1400)	800-1000 1200-1400		<input checked="" type="checkbox"/> <input checked="" type="checkbox"/>
Special alloys	Nimonic, Inconel, Monel, Hastelloy	≤1200		<input checked="" type="checkbox"/>
Ti and Ti-alloys	3.7024 Ti99,5, 3.7114 TiAl5Sn2,5, 3.7124 TiCu2 3.7154 TiAl6Zr5, 3.7165 TiAl6V4, 3.7184 TiAl4Mo4Sn2,5, - TiAl8Mo1V1	≤850 >850-1200		<input checked="" type="checkbox"/> <input checked="" type="checkbox"/>
Aluminium and Al-alloys	3.0255 Al99,5, 3.2315 AlMgSi1, 3.3515 AlMg1	≤400		<input checked="" type="checkbox"/>
Al wrought alloys	3.0615 AlMgSiPb, 3.1325 AlCuMg1, 3.3245 AlMg3Si, 3.4365 AlZnMgCu1,5	≤450		<input checked="" type="checkbox"/>
Al cast alloys ≤ 10 % Si	3.2131 G-AlSi5Cu1, 3.2153 G-AlSi7Cu3, 3.2573 G-AlSi9	≤600		<input checked="" type="checkbox"/>
> 10 % Si	3.2581 G-AlSi12, 3.2583 G-AlSi12Cu, - G-AlSi12CuNiMg	≤600		<input checked="" type="checkbox"/>
Magnesium alloys	3.5200 MgMn2, 3.5812.05 G-MgAl8Zn1, 3.5612.05 G-MgAl6Zn1	≤450		<input type="checkbox"/>
Copper, low alloyed	2.0070 SE-Cu, 2.1020 CuSn6, 2.1096 G-CuSn5ZnPb	≤400		<input checked="" type="checkbox"/>
Brass, short-chipping	2.0380 CuZn39Pb2, 2.0401 CuZn39Pb3, 2.0410 CuZn43Pb2	≤600		<input checked="" type="checkbox"/>
long-chipping	2.0250 CuZn20, 2.0280 CuZn33, 2.0332 CuZn37Pb0,5	≤600		<input checked="" type="checkbox"/>
Bronze, short-chipping	2.1090 CuSn7ZnPb, 2.1170 CuPb5Sn5, 2.1176 CuPb10Sn	≤600		<input checked="" type="checkbox"/>
long-chipping	2.0790 CuNi18Zn19Pb	>600-850		<input checked="" type="checkbox"/>
Bronze, long-chipping	2.0916 CuAl5, 2.0960 CuAl9Mn, 2.1050 CuSn10 2.0980 CuAl11Ni, 2.1247 CuBe2	≤850 >850-1000		<input checked="" type="checkbox"/> <input checked="" type="checkbox"/>

SuperV drills

Application recommendations

		Feed column									
Code-letter	A	B	C	D	E	F	G	H	I		
Drill-Ø mm	3,15	0,032	0,040	0,050	0,063	0,080	0,100	0,125	0,160	0,160	Feed f (mm/rev)
	4,00	0,040	0,050	0,063	0,080	0,100	0,125	0,160	0,200	0,200	
	5,00	0,040	0,050	0,063	0,080	0,100	0,125	0,160	0,200	0,250	
	6,30	0,050	0,063	0,080	0,100	0,125	0,160	0,200	0,250	0,315	
	8,00	0,063	0,080	0,100	0,125	0,160	0,200	0,250	0,315	0,315	
	10,00	0,080	0,100	0,125	0,160	0,200	0,250	0,315	0,400	0,400	
	12,50	0,080	0,100	0,125	0,160	0,200	0,250	0,315	0,400	0,500	
16,00	0,100	0,125	0,160	0,200	0,250	0,315	0,400	0,500	0,630		

Tools with feed column no. in bold are preferred choices for listed material group.

Generally recommendations:

For safety reasons it is very important, that a drill does not exceed a speed of $n = 6.000 \text{ rev./min}$ when unsupported. The centrifugal forces can break these long tools before reaching the workpiece surface!

Application recommendations for SuperV-T-drills:

In order to achieve optimal machining results when producing deep holes, we recommend:

- Production of a cylindrical pilot hole (tolerance F9) with a min. drilling depth of $1.5 \times D$ with our SuperV drill type U or VA (140° point angle, tolerance m7). Or alternatively the Pilot Drill-Mill cat. no. 54700
- Entry in the pilot hole: speed approx. 300 rev./min, feed rate approx. 500 mm/min.
- Turn on coolant pressure and speed.
- Continuous drilling to complete hole depth without withdrawing.
- For through holes with plain - i.e. 90° - exit, reduce feed rate v_f to 50% approx. 1 mm prior to break-through.
- For through holes with oblique exit, reduce the feed rate v_f to 40% approx. 1 mm prior to break-through.
- After reaching hole depth stop machine spindle and coolant supply, withdrawal with max. 5000 mm/min.

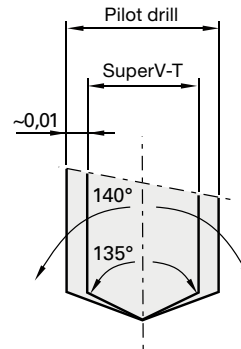

- Lubricants:**
- cutting oil, highly activated ■
 - soluble oil (emulsion) ■
 - without lubricant
 - air only

Material group	Materials examples, new designations (old designation in brackets) Figures in bold = material no. to DIN EN	Tensile strength MPa (N/mm ²)	Hardness	Coolant
General purpose steels	1.0035 S185(St33), 1.0486 P275N(StE285), 1.0345 P235GH(H1), 1.0425 P265GH(H2) 1.0050 E295 (St50-2), 1.0070 E360 (St70-2), 1.8937 P500NH (WStE500)	≤500 >500-850		■
Free-cutting steels	1.0718 11SMnPb30 (9SMnPb28), 1.0736 11SMn37 (9SMn36) 1.0727 46S20 (45S20), 1.0728 (60S20), 1.0757 46SPb20 (45SPb20)	≤850 850-1000		■
Unalloyed tempering steels	1.0402 C22, 1.1178 C30E (Ck30) 1.0503 C45, 1.1191 C45E (Ck45) 1.0601 C60, 1.1221 C60E (Ck60)	≤ 700 700-850 850-1000		■
Alloyed tempering steels	1.5131 50MnSi4, 1.7003 38Cr2, 1.7030 28Cr4 1.5710 36NiCr6, 1.7035 41Cr4, 1.7225 42CrMo4	850-≤1000 1000-1200		■
Unalloyed case hardened steels	1.0301 (C10), 1.1121 C10E (Ck10)	≤750		■
Alloyed case hardened steels	1.7043 38Cr4 1.5752 15NiCr13 (15NiCr13), 1.7131 16MnCr5, 1.7264 20CrMo5	850-≤1000 1000-1200		■
Nitriding steels	1.8504 34CrAl6 1.8519 31CrMoV9, 1.8550 34CrAlNi7	>850-≤1000 ≥1000-1200		■
Tool steels	1.1750 C75W, 1.2067 102Cr6, 1.2307 29CrMoV9 1.2080 X210Cr12, 1.2083 X42Cr13, 1.2419 105WCr6, 1.2767 X45NiCrMo4	≤850 >850-1000		■
High speed steels	1.3243 S 6-5-2-5, 1.3343 S 6-5-2, 1.3344 S 6-5-3	≥850-1000		■
Spring steels	1.5026 55Si7, 1.7176 55Cr3, 1.8159 51CrV4 (51CrV4)		≤330 HB	■
Hardened steels	-		≤40-48 HRC >48-60 HRC	■
Stainless steels, sulphured austenitic martensitic	1.4005 X12CrS13, 1.4104 X14CrMoS17, 1.4105 X6CrMoS17, 1.4305 X8CrNiS18-9 1.4301 X5CrNi18-10 (V2A), 1.4541 X6CrNiTi18-10, 1.4571 X6CrNiMoTi 17-12-2 (V4A) 1.4057 X20CrNi 17 2 (X17CrNi16-2), 1.4122 X39CrMo17-1, 1.4521 X2CrMoTi18-2	≤850 ≤850 ≤850		■
Cast iron	0.6010 EN-GJL-100(GG10), 0.6020 EN-GJL-200(GG20) 0.6025 EN-GJL-250(GG25), 0.6035 EN-GJL-350(GG35)	850-≤1000 1000-1200		■ □
Spheroidal graphite iron and malleable cast iron	0.7050 EN-GJS-500-7(GGG50), 0.8035 EN-GJMw-350-4(GTW35) 0.7070 EN-GJS-700-2(GGG70), 0.8170 EN-GJMB-700-2(GTS70)		≤240 HB <300 HB	■
Chilled cast iron	-		≤350 HB	■
New cast iron GGV	EN-GJV250 (GGV25), EN-GJV350 (GGV35) EN-GJV400 (GGV40), EN-GJV500 (GGV50), SiMo6			■ □
New cast iron ADI	EN-GJS-800-8 (ADI800), EN-GJS-1000-5 (ADI1000) EN-GJS-1200-2 (ADI1200), EN-GJS-1400-1 (ADI1400)	800-1000 1200-1400		■ □
Special alloys	Nimonic, Inconel, Monel, Hastelloy	≤1200		■
Ti and Ti-alloys	3.7024 Ti99,5, 3.7114 TiAl5Sn2,5, 3.7124 TiCu2 3.7154 TiAl6Zr5, 3.7165 TiAl6V4, 3.7184 TiAl4Mo4Sn2,5, - TiAl8Mo1V1	≤850 >850-1200		■
Aluminium and Al-alloys	3.0255 Al99,5, 3.2315 AlMgSi1, 3.3515 AlMg1	≤400		■
Al wrought alloys	3.0615 AlMgSiPb, 3.1325 AlCuMg1, 3.3245 AlMg3Si, 3.4365 AlZnMgCu1,5	≤450		■
Al cast alloys ≤ 10 % Si	3.2131 G-AlSi5Cu1, 3.2153 G-AlSi7Cu3, 3.2573 G-AlSi9	≤600		■
> 10 % Si	3.2581 G-AlSi12, 3.2583 G-AlSi12Cu, - G-AlSi12CuNiMg	≤600		■
Magnesium alloys	3.5200 MgMn2, 3.5812.05 G-MgAl8Zn1, 3.5612.05 G-MgAl6Zn1	≤450		□
Copper, low alloyed	2.0070 SE-Cu, 2.1020 CuSn6, 2.1096 G-CuSn5ZnPb	≤400		■
Brass, short-chipping	2.0380 CuZn39Pb2, 2.0401 CuZn39Pb3, 2.0410 CuZn43Pb2	≤600		■
long-chipping	2.0250 CuZn20, 2.0280 CuZn33, 2.0332 CuZn37Pb0,5	≤600		■
Bronze, short-chipping	2.1090 CuSn7ZnPb, 2.1170 CuPb5Sn5, 2.1176 CuPb10Sn	≤600		■
long-chipping	2.0790 CuNi18Zn19Pb 2.0916 CuAl5, 2.0960 CuAl9Mn, 2.1050 CuSn10 2.0980 CuAl11Ni, 2.1247 CuBe2	>600-850 ≤850 >850-1000		■
Duroplastics	Epoxidharz, Resopal, Pertinax, Moltopren		-	□
Thermoplastics	Plexiglass, Hostalen, Novodur, Makralon		-	□
Kevlar	Kevlar		-	□
Glass/carbon-concentr. plastics	GFK/CFK		-	□

Gun drills

Application recommendations

		Feed column no.							
Code-Letter		K	L	M	N	O	P	Q	R
Drill Ø mm	1,50	0,002	0,004	0,006	0,008	0,012	0,020	0,032	0,045
	2,00	0,003	0,005	0,007	0,010	0,016	0,028	0,046	0,055
	2,50	0,004	0,006	0,008	0,012	0,018	0,030	0,054	0,070
	4,00	0,005	0,007	0,010	0,016	0,025	0,043	0,065	0,085
	6,00	0,007	0,009	0,013	0,024	0,035	0,061	0,085	0,120
	8,00	0,010	0,014	0,022	0,032	0,045	0,068	0,100	0,150
	10,00	0,012	0,016	0,028	0,040	0,055	0,075	0,120	0,160
	14,00	0,020	0,025	0,035	0,050	0,065	0,085	0,130	0,180
	18,00	0,025	0,030	0,040	0,055	0,070	0,095	0,145	0,200
	20,00	0,026	0,035	0,045	0,060	0,080	0,110	0,180	0,250
	24,00	0,027	0,036	0,047	0,065	0,085	0,130	0,185	0,300
	28,00	0,028	0,038	0,049	0,068	0,090	0,140	0,195	0,350
	30,00	0,030	0,040	0,050	0,070	0,100	0,150	0,200	0,400
	35,00	0,035	0,045	0,055	0,075	0,120	0,180	0,250	0,450
	40,00	0,040	0,050	0,060	0,080	0,150	0,200	0,300	0,500

f (mm/rev)

Lubricants:

- cutting oil, highly activated, surface active lubricant with effective additives which chemically react and result in a special adhesive and abrasion reducing lubricant film.
- soluble oil (emulsion) without lubricant
- air only



Gun drills must never operate at full speed without guidance inside the machine. Please consider the additional information on page 6!

Material group	Materials examples, new designations (old designation in brackets) Figures in bold = material no. to DIN EN	Tensile strength MPa (N/mm ²)	Hardness	Coolant
General purpose steels	1.0035 S185(St33), 1.0486 P275N(StE285), 1.0345 P235GH(H1), 1.0425 P265GH(H2) 1.0050 E295 (St50-2), 1.0070 E360 (St70-2), 1.8937 P500NH (WStE500)	≤500 >500-850		<input checked="" type="checkbox"/> <input checked="" type="checkbox"/>
Free-cutting steels	1.0718 11SMnPb30 (9SMnPb28), 1.0736 11SMn37 (9SMn36) 1.0727 46S20 (45S20), 1.0728 (60S20), 1.0757 46SPb20 (45SPb20)	≤850 850-1000		<input checked="" type="checkbox"/> <input checked="" type="checkbox"/>
Unalloyed tempering steels	1.0402 C22, 1.1178 C30E (Ck30) 1.0503 C45, 1.1191 C45E (Ck45) 1.0601 C60, 1.1221 C60E (Ck60)	≤ 700 700-850 850-1000		<input checked="" type="checkbox"/> <input checked="" type="checkbox"/> <input checked="" type="checkbox"/>
Alloyed tempering steels	1.5131 50MnSi4, 1.7003 38Cr2, 1.7030 28Cr4 1.5710 36NiCr6, 1.7035 41Cr4, 1.7225 42CrMo4	850-≤1000 1000-1200		<input checked="" type="checkbox"/> <input checked="" type="checkbox"/>
Unalloyed case hardened steels	1.0301 (C10), 1.1121 C10E (Ck10)	≤750		<input checked="" type="checkbox"/>
Alloyed case hardened steels	1.7043 38Cr4 1.5752 15NiCr13 (15NiCr13), 1.7131 16MnCr5, 1.7264 20CrMo5	850-≤1000 1000-1200		<input checked="" type="checkbox"/> <input checked="" type="checkbox"/>
Nitriding steels	1.8504 34CrAl6 1.8519 31CrMoV9, 1.8550 34CrAlNi7	≥850-≤1000 >1000-1200		<input checked="" type="checkbox"/> <input checked="" type="checkbox"/>
Tool steels	1.1750 C75W, 1.2067 102Cr6, 1.2307 29CrMoV9 1.2080 X210Cr12, 1.2083 X42Cr13, 1.2419 105WCr6, 1.2767 X45NiCrMo4	≤850 >850-1000		<input checked="" type="checkbox"/> <input checked="" type="checkbox"/>
High speed steels	1.3243 S 6-5-2-5, 1.3343 S 6-5-2, 1.3344 S 6-5-3	≥650-1000		<input checked="" type="checkbox"/>
Spring steels	1.5026 55Si7, 1.7176 55Cr3, 1.8159 51CrV4 (51CrV4)		≤330 HB	<input checked="" type="checkbox"/>
Hardened steels	-		≤40-48 HRC >48-60 HRC	<input checked="" type="checkbox"/> <input checked="" type="checkbox"/>
Stainless steels, sulphured austenitic martensitic	1.4005 X12CrS13, 1.4104 X14CrMoS17, 1.4105 X6CrMoS17, 1.4305 X8CrNiS18-9 1.4301 X5CrNi18-10 (V2A), 1.4541 X6CrNiTi18-10, 1.4571 X6CrNiMoTi 17-12-2 (V4A) 1.4057 X20CrNi 17 2 (X17CrNi16-2), 1.4122 X39CrMo17-1, 1.4521 X2CrMoTi18-2	≤850 ≤850 ≤850		<input checked="" type="checkbox"/> <input checked="" type="checkbox"/> <input checked="" type="checkbox"/>
Cast iron	0.6010 EN-GJL-100(GG10), 0.6020 EN-GJL-200(GG20) 0.6025 EN-GJL-250(GG25), 0.6035 EN-GJL-350(GG35)	850-≤1000 1000-1200		<input checked="" type="checkbox"/> <input checked="" type="checkbox"/>
Spheroidal graphite iron and malleable cast iron	0.7050 EN-GJS-500-7(GGG50), 0.8035 EN-GJMW-350-4(GTW35) 0.7070 EN-GJS-700-2(GGG70), 0.8170 EN-GJMB-700-2(GTS70)		≤240 HB <300 HB	<input checked="" type="checkbox"/> <input checked="" type="checkbox"/>
Chilled cast iron	-		≤350 HB	<input checked="" type="checkbox"/>
New cast iron GGv	EN-GJV250 (GGV25), EN-GJV350 (GGV35) EN-GJV400 (GGV40), EN-GJV500 (GGV50), SiMo6			<input checked="" type="checkbox"/> <input checked="" type="checkbox"/>
New cast iron ADI	EN-GJS-800-8 (ADI800), EN-GJS-1000-5 (ADI1000) EN-GJS-1200-2 (ADI1200), EN-GJS-1400-1 (ADI1400)	800-1000 1200-1400		<input checked="" type="checkbox"/> <input checked="" type="checkbox"/>
Special alloys	Nimonic, Inconel, Monel, Hastelloy	≤1200		<input checked="" type="checkbox"/>
Ti and Ti-alloys	3.7024 Ti99,5, 3.7114 TiAl5Sn2,5, 3.7124 TiCu2 3.7154 TiAl6Zr5, 3.7165 TiAl6V4, 3.7184 TiAl4Mo4Sn2,5, - TiAl8Mo1V1	≤850 >850-1200		<input checked="" type="checkbox"/> <input checked="" type="checkbox"/>
Aluminium and Al-alloys	3.0255 Al99,5, 3.2315 AlMgSi1, 3.3515 AlMg1	≤400		<input checked="" type="checkbox"/>
Al wrought alloys	3.0615 AlMgSiPb, 3.1325 AlCuMg1, 3.3245 AlMg3Si, 3.4365 AlZnMgCu1,5	≤450		<input checked="" type="checkbox"/>
Al cast alloys ≤ 10 % Si	3.2131 G-AlSi5Cu1, 3.2153 G-AlSi7Cu3, 3.2573 G-AlSi9	≤600		<input checked="" type="checkbox"/>
> 10 % Si	3.2581 G-AlSi12, 3.2583 G-AlSi12Cu, - G-AlSi12CuNiMg	≤600		<input checked="" type="checkbox"/>
Magnesium alloys	3.5200 MgMn2, 3.5812.05 G-MgAl8Zn1, 3.5612.05 G-MgAl6Zn1	≤450		<input type="checkbox"/>
Copper, low alloyed	2.0070 SE-Cu, 2.1020 CuSn6, 2.1096 G-CuSn5ZnPb	≤400		<input checked="" type="checkbox"/> <input checked="" type="checkbox"/>
Brass, short-chipping long-chipping	2.0380 CuZn39Pb2, 2.0401 CuZn39Pb3, 2.0410 CuZn43Pb2 2.0250 CuZn20, 2.0280 CuZn33, 2.0332 CuZn37Pb0,5	≤600 ≤600		<input checked="" type="checkbox"/> <input checked="" type="checkbox"/>
Bronze, short-chipping	2.1090 CuSn7ZnPb, 2.1170 CuPb5Sn5, 2.1176 CuPb10Sn 2.0790 CuNi18Zn19Pb	≤600 >600-850		<input checked="" type="checkbox"/> <input checked="" type="checkbox"/>
Bronze, long-chipping	2.0916 CuAl5, 2.0960 CuAl9Mn, 2.1050 CuSn10 2.0980 CuAl11Ni, 2.1247 CuBe2	≤850 >850-1000		<input checked="" type="checkbox"/> <input checked="" type="checkbox"/>
Duroplastics	Epoxidharz, Resopal, Pertinax, Moltopren		-	<input type="checkbox"/>
Thermoplastics	Plexiglass, Hostalen, Novodur, Makralon		-	<input checked="" type="checkbox"/> <input type="checkbox"/>
Kevlar	Kevlar		-	<input type="checkbox"/>
Glass/carbon-concentr. plastics	GFK/CFK		-	<input type="checkbox"/>

Catalog no.	55027 55028 55029	75024 75020 75026 75021	55024 55020 55026 55021	75018 75017 75022 75023	55018 55017 55022 55023	65030 65031 65032 65033
Tool material	Solid carbide	Solid carbide	Solid carbide	Carbide	Carbide	Carbide
Surface finish	AlTiN nano	bright	AlTiN +	TiN	TiCN	TiN
Type	SuperT-AI	TBE-VHM	TBE-VHM	SuperT-N	SuperT-NX	SuperT-NXL
Page	33/34/35	25/27/29/31	26/28/30/32	36/37/38/39	40/41/42/43	45/46/47/48



V _c m/min	Feed column no.	V _c m/min	Feed column no.	V _c m/min	Feed column no.	V _c m/min	Feed column no.	V _c m/min	Feed column no.	V _c m/min	Feed column no.
100	O	95	N	95	N	95	M	95	M	100	N
85	O	80	N	80	N	80	M	80	M	85	N
90	O	85	N	85	N	85	M	85	M	90	N
80	O	75	N	75	N	75	M	75	M	80	N
90	N	85	M	85	M	85	L	85	L	90	M
80	N	75	M	75	M	75	L	75	L	80	M
75	N	70	M	70	M	70	L	70	L	75	M
75	N	70	M	70	M	70	L	70	L	75	M
65	N	60	M	60	M	60	L	60	L	65	M
80	O	75	N	75	N	75	M	75	M	80	N
75	N	70	M	70	M	70	L	70	L	75	M
65	N	60	M	60	M	60	L	60	L	65	M
75	N	70	M	70	M	70	L	70	L	75	M
65	N	60	M	60	M	60	L	60	L	65	M
75	M	70	L	70	L	70	K	70	K	75	L
65	M	60	L	60	L	60	K	60	K	65	L
55	L	50	K	50	K	50	K	50	K	55	K
65	M	60	L	60	L	60	L	60	L	65	L
30	M	25	L	25	L	25	K	25	K	30	L
										25	K
55	N	50	M	50	M	50	L	50	L	55	M
45	N	40	M	40	M	40	L	40	L	45	M
35	N	35	M	35	M	35	L	35	L	35	M
85	P	80	O	80	O	80	N	80	N	85	O
80	P	75	O	75	O	75	N	75	N	80	O
80	O	75	N	75	N	75	M	75	M	80	N
70	O	65	N	65	N	65	M	65	M	70	N
55	N	50	M	50	M	50	L	50	L	55	M
25	L	20	K	20	K	20	K	20	K	35	K
35	L	30	K	30	K	30	K	30	K	35	K
30	L	25	K	25	K	25	K	25	K	30	K
150	Q	140	P	140	P	140	N	140	N	150	P
120	Q	115	P	115	P	115	N	115	N	120	O
150	R	140	Q	140	Q	140	P	140	P	150	P
130	R	120	Q	120	Q	120	P	120	P	130	P
110	Q	100	P	100	P	90	O	90	O	110	P
75	O	70	N	70	N	70	M	70	M	75	N
120	R	115	Q	115	Q	115	P	115	P	120	Q
90	R	85	Q	85	Q	85	P	85	P	90	Q
95	Q	90	P	90	P	90	O	90	O	95	P
75	Q	70	P	70	P	70	O	70	O	75	P
70	Q	65	P	65	P	65	O	65	O	70	P
60	Q	55	P	55	P	55	O	55	O	60	P
75	O	70	N	70	N	70	M	70	M	75	N
70	O	65	N	65	N	65	M	65	M	70	N
60	N	55	M	55	M	55	L	55	L	60	M
50	N	45	M	45	M	45	L	45	L	50	M

Gun Drills

Coolant values recommendations

Coolant values SuperV-T

(Recommended values for soluble oil)

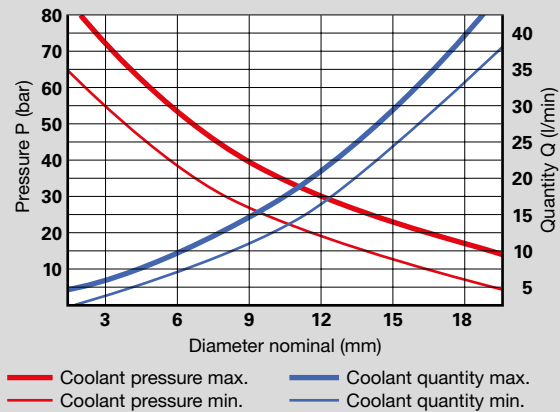

Coolant values TBE-VHM/SuperT-AL

(Recommended values for soluble oil)

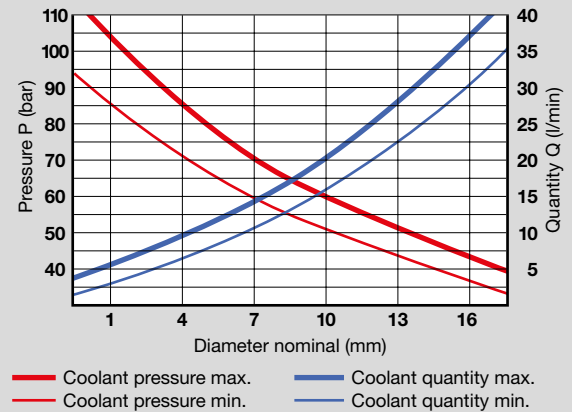

Coolant values SuperT-N/-NX/-NXL

(Recommended values for soluble oil)

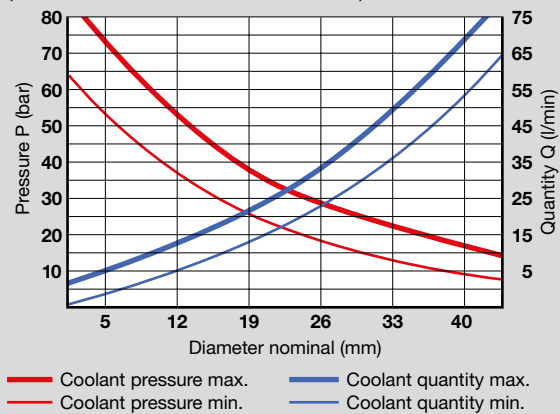

Coolant values SuperV-NX

(Recommended values for soluble oil)

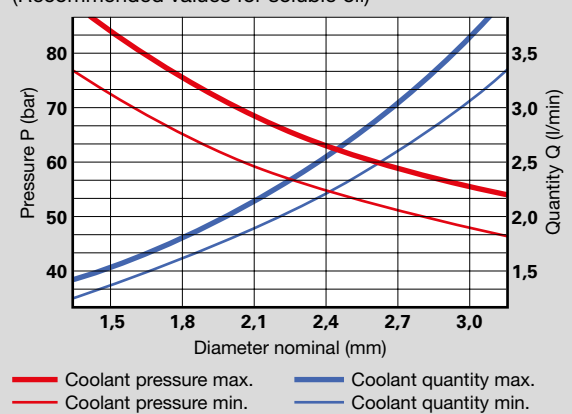

Precision of single-fluted deep hole gun drills

Basic tolerance*

The application of single-fluted gun drills can achieve a lower basic tolerance, as the cutting forces at the cutting edge are absorbed by the supporting strips, unlike twist drills where the slightest deviation of the two cutting edges causes a larger hole.

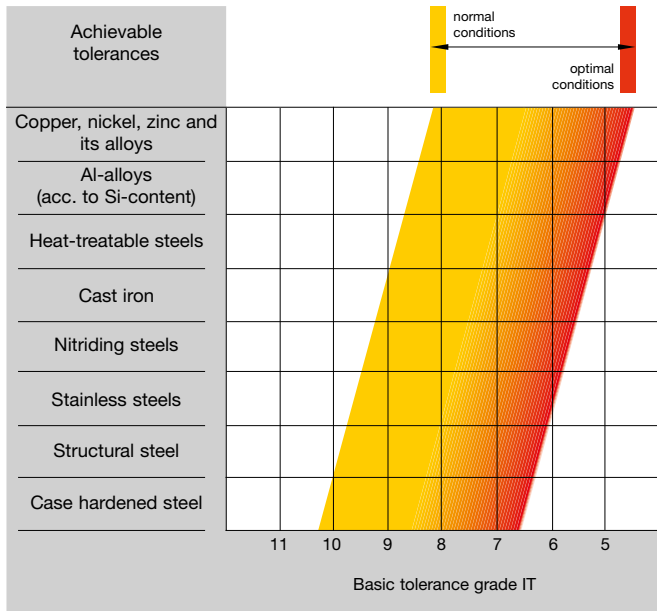

Alignment accuracy*

Because brazed single-fluted gun drills always have the precision carbide head brazed on to a flexible tube, the tool achieves very accurate aligned holes remaining unaffected by possible concentricity errors. However, extreme material fluctuations and other influencing factors can impair the alignment accuracy.

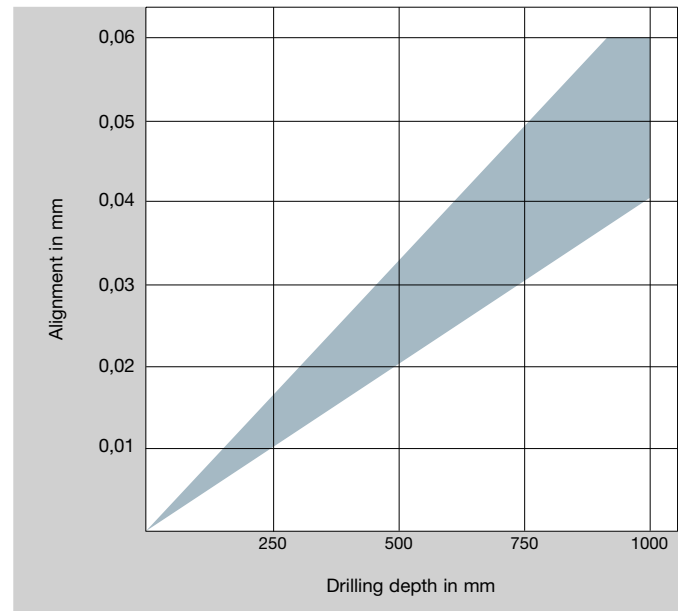

Surface quality*

The forces at the cutting edge are absorbed by the support bushes, which in return burnishes the surface. Lubrication between the supporting strips and hole surface is therefore very important. The better the lubricant, the better the surface quality.

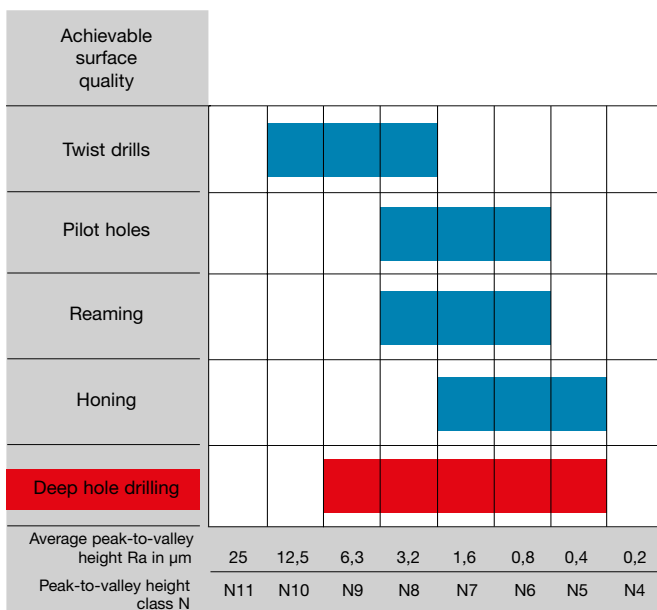

Deviation from concentricity*

When a hole is produced with for example, a commercial twist drill, the quality of the point grind affects the concentricity of the hole. An imbalance of forces is created at the cutting edges. With gun drills, these cutting forces are absorbed by the supporting strips, resulting in excellent concentricity.

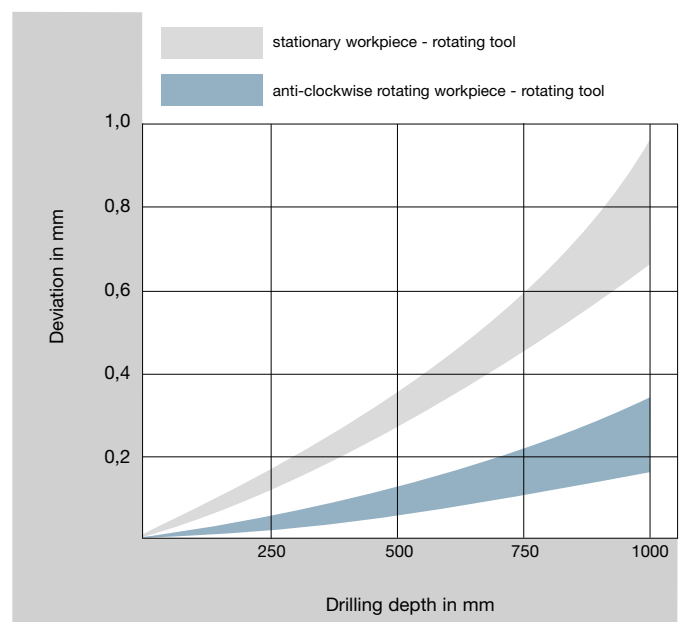

* Deep hole drills with two cutting edges - straight-fluted as well as spiral-fluted - achieve approx. 50% of the values stated.

Drivers

The range of drivers introduced below is available ex stock. However, it only represents a small selection of drivers from our complete range. We naturally also produce individual drivers of

the highest precision according to customer drawings. Attention! TBE-VHM requires drivers with positioning lugs. Further information on request.

Drivers for deep drilling machines

1

Code	d ₁	l ₁	l ₂	l ₃
1.1	10	40	24	-
1.2	10	40	24	45
1.3	10	40	24	55
1.4	16	45	31,2	-
1.5	25	70	34	-
1.6	25	70	34	78

5

Code	d ₁	l ₁	l ₂
5.1	10	60	20
5.2	16	80	28
5.3	25	100	50
5.4	10	100	-
5.5	10	110	-

2

Code	d ₁	l ₁	l ₂	l ₃
2.1	16	50	47	-
2.2	16	50	47	55
2.3	16	50	47	70

6

Code	d ₁	l ₁
6.1	12,7	38
6.2	19,05	70
6.3	38,1	70

3

Code	d ₁	l ₁	l ₂	l ₃
3.1	25	70	34	100

7

Code	d ₁	l ₁	l ₂
7.1	16	112	73
7.2	20	126	82

4

Code	d ₁	l ₁
4.1	19,05	70
4.2	12,70	70
4.3	25,40	70
4.4	31,75	70
4.5	36,10	70

Drivers to DIN 1835

form E

9

Code	d ₁	l ₁
9.1	8	36
9.2	10	40
9.3	12	45
9.4	16	48
9.5	20	50
9.6	25	56
9.7	32	60
9.8	31,75	70
9.9	38,1	70
9.10	40	70

Drivers to DIN 6535

form HA

10

Code	d ₁	l ₁
10.1	8	36
10.2	10	40
10.3	12	45
10.4	16	48
10.5	20	50
10.6	25	56
10.7	32	60
10.8	25	70
10.9	40	70

Drivers to VDI draft

12

Code	d ₁	l ₁
12.1	10	68
12.2	16	90
12.3	25	112

form HB

8

with code 8.6, 8.7, 8.8

Code	d ₁	l ₁
8.1	8	36
8.2	10	40
8.3	12	45
8.4	16	48
8.5	20	50
8.6	25	56
8.7	32	60
8.8	40	70

also used for deep hole drilling machines

Drivers to Speed-Bit-System

13

Code	d ₁	l ₁	l ₂
13.1	16	40	16
13.2	25	50	25
13.2	35,6	60	-

also used for deep hole drilling machines

form HE

11

Code	d ₁	l ₁
11.1	8	36
11.2	10	40
11.3	12	45
11.4	16	48
11.5	20	50
11.6	25,4	70
11.7	25	56
11.8	32	60
11.9	40	70

Variations for drivers at gun drills with tube shank

Solution for nom.-Ø < driver-Ø
(difference must be appr. 6mm):
tube shank installed in driver

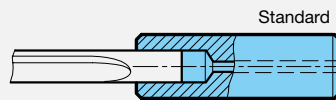

Solution for nom.-Ø = driver-Ø
(close to parallel):
tube shank installed over collar

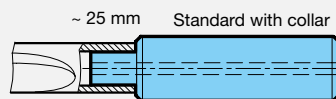

Solution for nom.-Ø > driver-Ø:
tube shank installed over collar,
inside-Ø of tube shank > driver-Ø,
tube shank fits against flange shoulder.

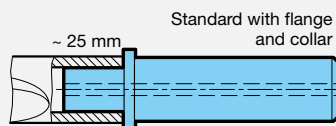

similar to form HA (shrinkable)

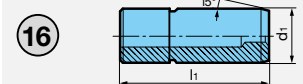

Code	d ₁	l ₁
16.1	10	50
16.2	16	64
16.3	20	70
16.4	25	81
16.5	32	92

similar to form HE

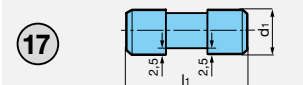

Code	d ₁	l ₁
17.1	19,05	70
17.2	25,40	70
17.3	31,75	70
17.4	38,1	70

also used for deep hole drilling machines

Accessories for deep hole drilling machines

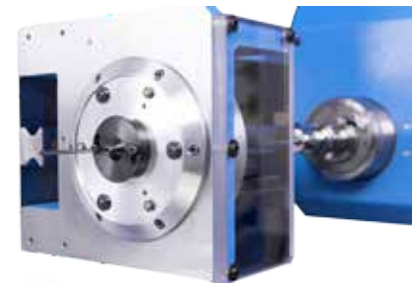

In contrast to conventional machine tools, certain accessories, i.e. drilling bushes, seal discs, steady rest bushings etc., are part of the standard equipment on deep hole drilling machines. Because of the multitude of accessories currently available, it is impossible to list tables with dimensions for each item in this brochure. However, we can supply most of products generally applied on request (with drawing if possible).

Additional technical parameters

Special point grinds for single-fluted gun drills

with recessed coolant chamber

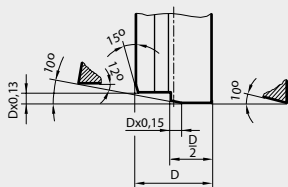

with chip breaker

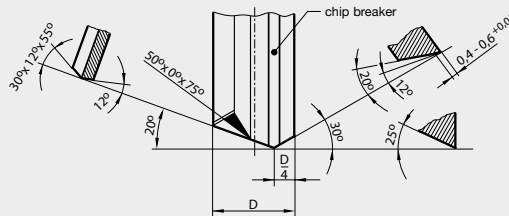

with chip guiding step

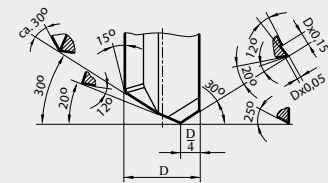

Head forms

(position of supporting strips)



Standard design

Suitable for all materials, but for smaller hole tolerances



Suitable for difficult-to-machine materials, i.e. high-alloyed steels

Supporting strip



Special designs

Suitable for all materials, but for larger hole tolerances



Suitable for all materials, but only when spotting conditions are unfavourable



This design is predominantly suitable for grey cast iron

Backtaper ratio for gun drills

(dimensions in mm)

1:600

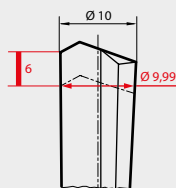

1:800 (Standard)

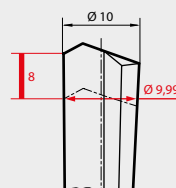

1:1000

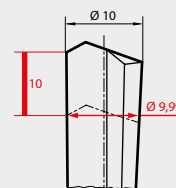

Single-fluted gun drills with interchangeable inserts

Type TBE-WP

Stock single-fluted gun drills with interchangeable inserts and supporting strips are solely available as special tools for customers specific applications. They are suitable for the machining of nearly every material and can be manufactured from diameter 12.0 mm to 52.0 mm with maximum total length up to 3.000 mm. For Drilling depth 30xD standard sizes are available ex stock.

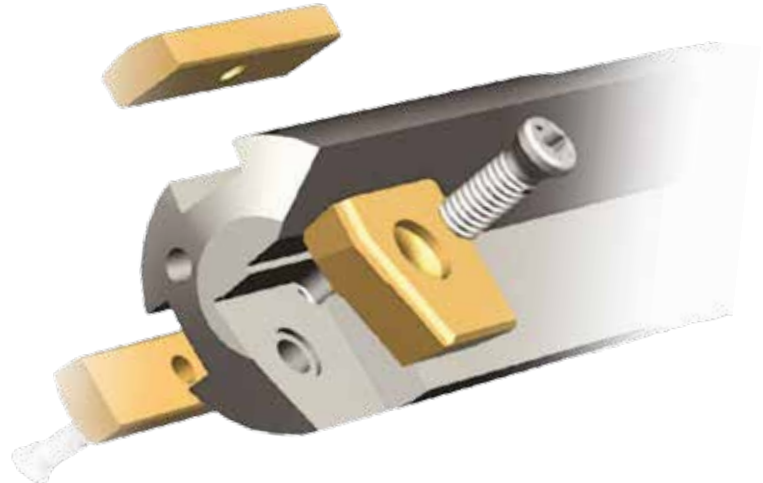

The special advantages are:

- The interchangeable component technology for inserts and supporting strips makes any combination of carbide grade and coating possible.
 - The precision interchangeable inserts and supporting strips eliminate complicated adjustments.
 - The precision supporting strips are produced out of a special carbide for your individual deep drilling task. They can be reverse-fitted, providing double tool life.
 - Thanks to the precision insert seatings and the interchangeable inserts there is only a small number of interchangeable components. The tool is therefore extremely rigid.
 - Expensive stoppages are eliminated because the worn components can be replaced without removing the tool from the machine.
 - The expensive regrinding process is eliminated thanks to the interchangeable insert technology.
 - The application orientated selection of the most suitable interchangeable insert always ensures optimal chip breaking – even in problematic materials.
 - Specifically optimised to your individual deep drilling task, the precision inter-changeable inserts are also made out of a special carbide grade.
 - Within the diameter range it is possible to modify the nominal diameter at any time by simply interchanging the individual components.
 - The drivers are produced in heat-treatable steel acc. to:
 - DIN 6535 HA
 - DIN 6535 HB
 - DIN 6535 HE
 - DIN 1835 E
- Also, all other forms which are generally required for deep drilling machines are possible to be manufactured.

Size	Diameter range (mm)	Size	Diameter range (mm)	Size	Diameter range (mm)
0.00	12.00 - 12.49	3.02	27.00 - 27.49	7.04	42.00 - 42.49
0.01	12.50 - 12.99	3.03	27.50 - 27.99	7.05	42.50 - 42.99
0.02	13.00 - 13.49	3.04	28.00 - 28.49	7.06	43.00 - 43.49
0.03	13.50 - 13.99	3.05	28.50 - 28.99	7.07	43.50 - 43.99
0.04	14.00 - 14.49	3.06	29.00 - 29.49	8.00	44.00 - 44.49
0.05	14.50 - 14.99	3.07	29.50 - 29.99	8.01	44.50 - 44.99
0.06	15.00 - 15.49	4.00	30.00 - 30.49	8.02	45.00 - 45.49
0.07	15.50 - 15.99	4.01	30.50 - 30.99	8.03	45.50 - 45.99
1.00	16.00 - 16.49	4.02	31.00 - 31.49	8.04	46.00 - 46.49
1.01	16.50 - 16.99	4.03	31.50 - 31.99	8.05	46.50 - 46.99
1.02	17.00 - 17.49	4.04	32.00 - 32.49	8.06	47.00 - 47.49
1.03	17.50 - 17.99	4.05	32.50 - 32.99	8.07	47.50 - 47.99
1.04	18.00 - 18.49	4.06	33.00 - 33.49	9.00	48.00 - 48.49
1.05	18.50 - 18.99	4.07	33.50 - 33.99	9.01	48.50 - 48.99
1.06	19.00 - 19.49	5.00	34.00 - 34.49	9.02	49.00 - 49.49
1.07	19.50 - 19.99	5.01	34.50 - 34.99	9.03	49.50 - 49.99
2.00	20.00 - 20.49	5.02	35.00 - 35.49	9.04	50.00 - 50.49
2.01	20.50 - 20.99	5.03	35.50 - 35.99	9.05	50.50 - 50.99
2.02	21.00 - 21.49	5.04	36.00 - 36.49	9.06	51.00 - 51.49
2.03	21.50 - 21.99	5.05	36.50 - 36.99	9.07	51.50 - 52.00
2.04	22.00 - 22.49	5.06	37.00 - 37.49		
2.05	22.50 - 22.99	5.07	37.50 - 37.99		
2.06	23.00 - 23.49	6.00	38.00 - 38.49		
2.07	23.50 - 23.99	6.01	38.50 - 38.99		
2.08	24.00 - 24.49	6.02	39.00 - 39.49		
2.09	24.50 - 24.99	6.03	39.50 - 40.00		
2.10	25.00 - 25.49	7.00	40.01 - 40.49		
2.11	25.50 - 25.99	7.01	40.50 - 40.99		
3.00	26.00 - 26.49	7.02	41.00 - 41.49		
3.01	26.50 - 26.99	7.03	41.50 - 41.99		

Questionnaire

Single-fluted gun drills with interchangeable inserts

Ø 12.0 - 52.0 mm, flute length min. 15xD, total length max. 3000 mm

Quantity _____

Coating

- TiN
 TiCN
 TiAlN
 AlTiN nano
 AlTiN+
 AlTiN

Material

Material to be machined _____ Tensile strength/Hardness _____ N/mm²/HRC

Machine type

- Deep hole drilling machine
 Conventional machine tool

Coolant

- Deep hole drilling oil
 Soluble oil

Coolant pressure

_____ bar

Driver

- none
 Code _____ (*see page 58)

Workpiece

Drilling depth _____ mm Hole tolerance _____

Dimensions

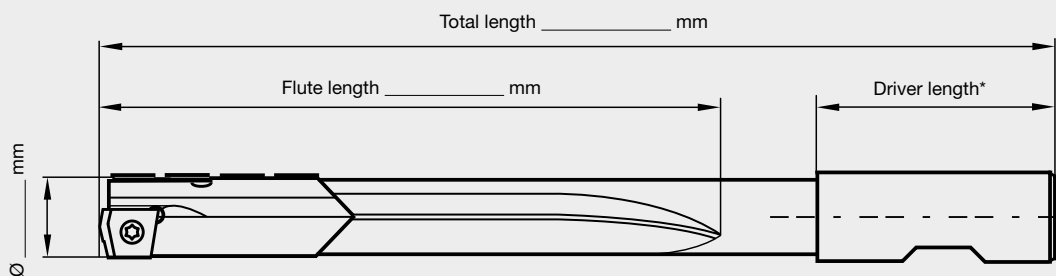

Contact

Company: _____

Company stamp: _____

Contact person: _____

Telephone / Fax: _____

Date: _____

Email address: _____

Signature: _____

Questionnaire

Solid carbide single-fluted gun drill

Ø 0.9 - 12.0 mm, flute length max. 500 mm

Quantity _____

similar catalogue tool _____

Coating

bright

TiN

TiAlN

AlTiN nano

AlTiN+

Material

Material to be machined _____

Tensile strength/Hardness _____ N/mm²/HRC

Machine type

Deep hole drilling machine

Conventional machine tool (max. 80xD)

Coolant

Deep hole drilling oil

Soluble oil

Coolant pressure

_____ bar

Driver

none

Code _____ (*see page 58)

Workpiece

Drilling depth _____ mm

Hole tolerance _____

Dimensions

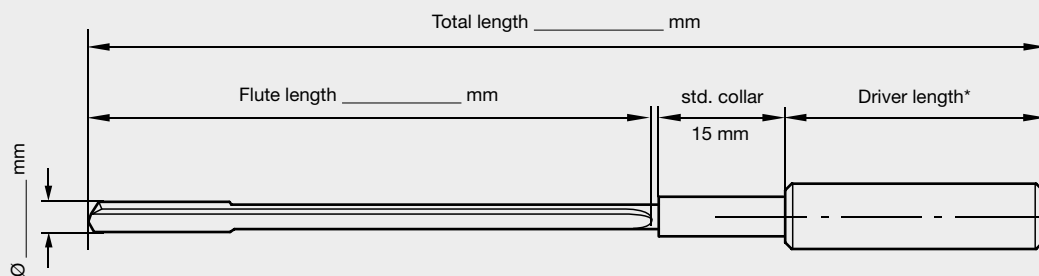

Contact

Company: _____

Company stamp: _____

Contact person: _____

Telephone / Fax: _____

Date: _____

Email address: _____

Signature: _____

Questionnaire

Single-fluted gun drills with brazed carbide head

Ø 2.0 - 40.0 mm, total length max. 3000 mm

Quantity _____

similar catalogue tool _____

Coating

bright

TiN

TiCN

Zusatz

Lateral chip breaker

Material

Material to be machined _____

Tensile strength/Hardness _____ N/mm²/HRC

Machine type

Deep hole drilling machine

Conventional machine tool (max. 40xD)

Coolant

Deep hole drilling oil

Soluble oil

Coolant pressure

_____ bar

Driver

none

Code _____ (*see page 58)

Workpiece

Drilling depth _____ mm

Hole tolerance _____

Length of chip separator _____ mm

Dimensions

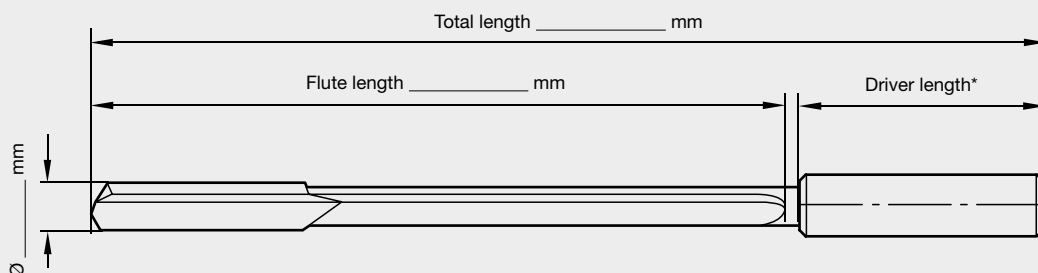

Contact

Company: _____

Company stamp: _____

Contact person: _____

Telephone / Fax: _____

Date: _____

Email address: _____

Signature: _____

Catalogue no.	Page	Standard	Surface	Description	Tool material	Type
51764	19	Company std.	AlTiN	SuperV drills with internal coolant	Solid carbide	SuperV-T
51765	20	Company std.	AlTiN	SuperV drills with internal coolant	Solid carbide	SuperV-T
51766	21	Company std.	AlTiN	SuperV drills with internal coolant	Solid carbide	SuperV-T
51767	22	Company std.	AlTiN	SuperV drills with internal coolant	Solid carbide	SuperV-T
51768	23	Company std.	AlTiN	SuperV drills with internal coolant	Solid carbide	SuperV-T
51999	18	Company std.	AlTiN	SuperV-NX high-performance microdrills with int. coolant	Solid carbide	SuperV-IK-NX
55017	41	Company std.	TiCN	Gun drills, type SuperT-NX	Carbide	SuperT-NX
55018	40	Company std.	TiCN	Gun drills, type SuperT-NX	Carbide	SuperT-NX
55020	28	Company std.	AlTiN+	Gun drills, type TBE-VHM	Solid carbide	TBE-VHM
55021	32	Company std.	AlTiN+	Gun drills, type TBE-VHM	Solid carbide	TBE-VHM
55022	42	Company std.	TiCN	Gun drills, type SuperT-NX	Carbide	SuperT-NX
55023	43	Company std.	TiCN	Gun drills, type SuperT-NX	Carbide	SuperT-NX
55024	26	Company std.	AlTiN+	Gun drills, type TBE-VHM	Solid carbide	TBE-VHM
55026	30	Company std.	AlTiN+	Gun drills, type TBE-VHM	Solid carbide	TBE-VHM
55027	33	Company std.	AlTiN nano	Gun drills, type SuperT-AL	Solid carbide	SuperT-AL
55028	34	Company std.	AlTiN nano	Gun drills, type SuperT-AL	Solid carbide	SuperT-AL
55029	35	Company std.	AlTiN nano	Gun drills, type SuperT-AL	Solid carbide	SuperT-AL
65030	45	Company std.	TiN	Gun drills, type SuperT-NXL	Carbide	SuperT-NXL
65031	46	Company std.	TiN	Gun drills, type SuperT-NXL	Carbide	SuperT-NXL
65032	47	Company std.	TiN	Gun drills, type SuperT-NXL	Carbide	SuperT-NXL
65033	48	Company std.	TiN	Gun drills, type SuperT-NXL	Carbide	SuperT-NXL
75017	37	Company std.	TiN	Gun drills, type SuperT-N	Carbide	SuperT-N
75018	36	Company std.	TiN	Gun drills, type SuperT-N	Carbide	SuperT-N
75020	27	Company std.	bright	Gun drills, type TBE-VHM	Solid carbide	TBE-VHM
75021	31	Company std.	bright	Gun drills, type TBE-VHM	Solid carbide	TBE-VHM
75022	38	Company std.	TiN	Gun drills, type SuperT-N	Carbide	SuperT-N
75023	39	Company std.	TiN	Gun drills, type SuperT-N	Carbide	SuperT-N
75024	25	Company std.	bright	Gun drills, type TBE-VHM	Solid carbide	TBE-VHM
75026	29	Company std.	bright	Gun drills, type TBE-VHM	Solid carbide	TBE-VHM



ISO-CODES

P	Steel, high-alloyed steel
M	Stainless steel
K	Grey cast iron, spheroidal and malleable cast iron
N	Aluminium and other non-ferrous metals
S	Special-, super- and Ti-alloys
H	Hardened steel and hard cast iron

Recommendations regarding tool suitability for the following application groups can be found on the following programme pages:

- optimal suitability
- limited suitability

PICTOGRAMS



TOOL MATERIAL	VHM	HM						
	Solid carbide		Carbide					
SURFACE FINISH	bright	AlTiN nano	TiCN	TiN	Al-TiN	Al-TiN+		
Ø TOLERANCE	h5	h7						
DRILLING DEPTH	15xD	20xD	25xD	30xD	40xD	50xD	75xD	80xD
CUTTING DIRECTION		right-hand						
SHANK FORM			Driver					
POINT ANGLE								
STANDARD		to Stock standard						
TYPE	SuperT-AI	SuperT-N	SuperT-NX	SuperT-NXL	SuperV-IK-NX	SuperV-T	TBE-VHM	



Gun drills

Our programme

Products

Twist Drills
Taps
Milling Cutters
Reamers
Countersinks & -bores
Chamfering Tools
Special HSS and Carbide Tools
(to your specifications or our solutions)
Tool holders

Services

Regrinding
Modifications
Recoating
Paid labour coating
Coating removal
Intelligent Tool Depot Systems
Technical assistance

Your local contact:



R. Stock AG

Lengeder Strasse 29-35 • 13407 Berlin, Germany • Phone: +49 30 40 90 3-33 300
Fax: +49 30 40 90 3-33 324 • Mail: sales@stock.de

www.stock.de